

# ECOPHON SOLO™ PENTAGON

Solo Pentagon is a free-hanging unit, offering high level design possibilities. Three different suspension systems offer opportunities to create several layers and angles. Suitable when the room volume should be maintained or when it's not possible to install a wall-to-wall ceiling.



# Ecophon Solo™ Pentagon



## SYSTEM RANGE

Size, mm	1139x1198
Special Fixing	•
Thickness (THK)	40
Inst. Diagr.	M427

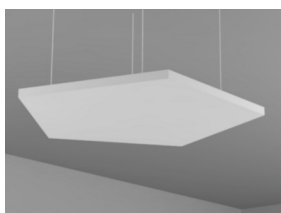

Acoustic panel Solo Freedom in cloud shape



Suspension with Connect Adjustable wire hanger and Connect Absorber anchor

## TYPE OF APPLICATION

- Healthcare
- Office



## ACOUSTIC

The values in the diagram refer to a single unit. If the units are arranged in a cluster with distances between units less than 0,5 meters, the Aeq per unit will be slightly reduced.

### Sound Absorption

Based on test results according to EN ISO 354.

A<sub>eq</sub>, Equivalent absorption area per unit (m<sup>2</sup> sabin)

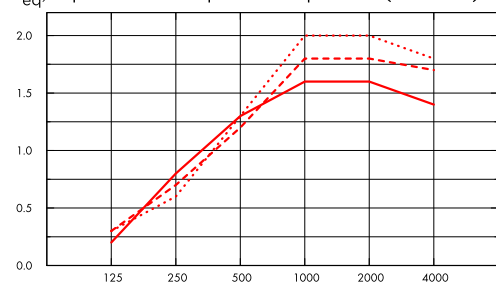

- Solo Pentagon 1139x1198, 200 mm o.d.s.
  - - - Solo Pentagon 1139x1198, 400 mm o.d.s.
  - ⋯ Solo Pentagon 1139x1198, 1000 mm o.d.s.
- o.d.s = overall depth of system

THK mm	o.d.s. mm	A <sub>eq</sub> , Equivalent absorption area per unit (m <sup>2</sup> sabin)					
		125 Hz	250 Hz	500 Hz	1000 Hz	2000 Hz	4000 Hz
40	200	0.2	0.8	1.3	1.6	1.6	1.4
40	400	0.3	0.7	1.2	1.8	1.8	1.7
40	1000	0.3	0.6	1.3	2.0	2.0	1.8

## INDOOR AIR QUALITY



Certificate / Label	
Eurofins Indoor Air Comfort®	IAC Gold
French VOC	A+



## CRADLE TO CRADLE CERTIFIED®

This product is Cradle to Cradle Certified® at Bronze level (version 4.0).



### MATERIAL HEALTH

This product has received a C2C Certified Material Health Certificate™ at the Silver level (standard version 4.0). The C2C Certified Material Health Certificate™ is a verification of the health and safety of a product's composition using the Material Health requirements of the Cradle-to-Cradle Certified Product Standard.



### CARBON FOOTPRINT

Life-cycle stages A1 to C4 from EPD, in conformity with ISO 14025 / EN 15804

	kg CO <sub>2</sub> equiv/m <sup>2</sup>
Solo Freedom	8,41 (Solo Family EPD in conformity with ISO 14025 / EN 15804)



### CIRCULARITY

Minimum post-consumer recycled content	57%
Recyclability	Fully recyclable



### FIRE SAFETY

The glass wool core of the tiles is tested and classified as non-combustible according to EN ISO 1182.

Country	Fire standard	Class
Europe	EN 13501-1	A2-s1,d0



### HUMIDITY RESISTANCE

Class C, relative humidity 95% and 30°C, according to EN 13964:2014



### VISUAL APPEARANCE

White Frost, nearest NCS colour sample S 0500-N, 85% light reflectance. Gloss < 1.



### CLEANABILITY

Daily dusting and vacuum cleaning. Weekly wet wiping.



### ACCESSIBILITY

The tiles are demountable.



### INSTALLATION

Installed according to installation diagrams, installation guides and drawing aid. For information regarding minimum overall depth of system see quantity specification.



### PACKAGING INFORMATION

Information is indicative and subject to change.

	Panels / crt
1139x1198	4



### SYSTEM WEIGHT

Weight information is indicative and subject to variation.

	kg/m <sup>2</sup>
Solo Pentagon	4,7



## MECHANICAL PROPERTIES

The tile can take both point loads and distributed loads. See Functional demands, Mechanical properties at [www.ecophon.com](http://www.ecophon.com).





## CE

Ecophon ceiling systems are CE marked according to the European harmonized standard EN13964:2014. CE marked construction products are covered by a Declaration of Performance (DOP) which enables customers and users to easily compare performance of products available on the European market.

## COLOURS AND DESIGN

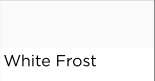
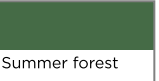
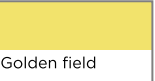
### Akutex™ FT

 White Frost	 Moonlight sky	 Highland fog	 Sunset heat	 Ocean storm	 Morning drizzle	 Peach rose
 Goji berry	 Scallop shells	 Fresh clover	 Sage garden	 Eucalyptus leaf	 Summer forest	 Golden field
 Ruby rock	 Wet sand	 Silent steam	 Dark diamond	 Cloudy day	 Volcanic ash	 Silver stone
 Silk slate						

Wire

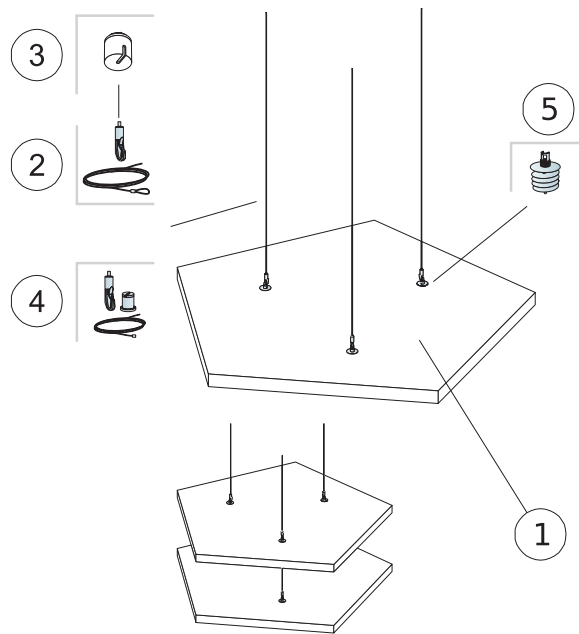

Installation diagram (M427) for Ecophon Solo Pentagon

Quantity specification (excl. wastage)

		Size, mm
		1139x1198
1	Solo Pentagon	0,94m <sup>2</sup> /panel
2	Connect Adjustable wire hanger (Alt 1)	3/panel
3	Connect Covering cup (Alt 1, Optional)	3/panel
4	Connect Adjustable wire Kit (Alt 1, Optional)	3/panel
5	Connect Absorber anchor (Alt 1)	3/panel
Δ Min. overall depth of system: 140 mm		
To install Connect Absorber Anchor, use Connect Absorber Anchor Bit.		

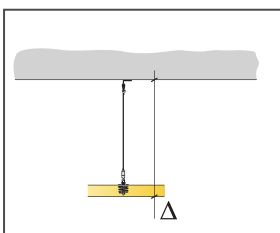

See Quantity specification

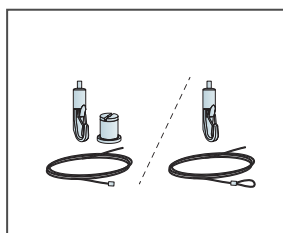

Two types of Adjustable wire solutions

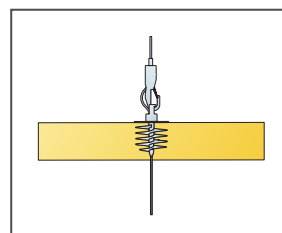

Panels can be suspended underneath each other

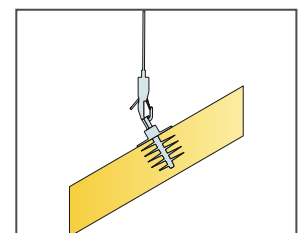

Panels can be installed in angles