

Ecophon Hygiene Black™ Ds Edge

600x600
1200x600

IG676C4

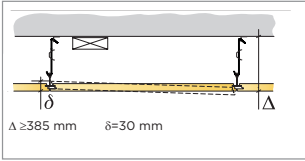
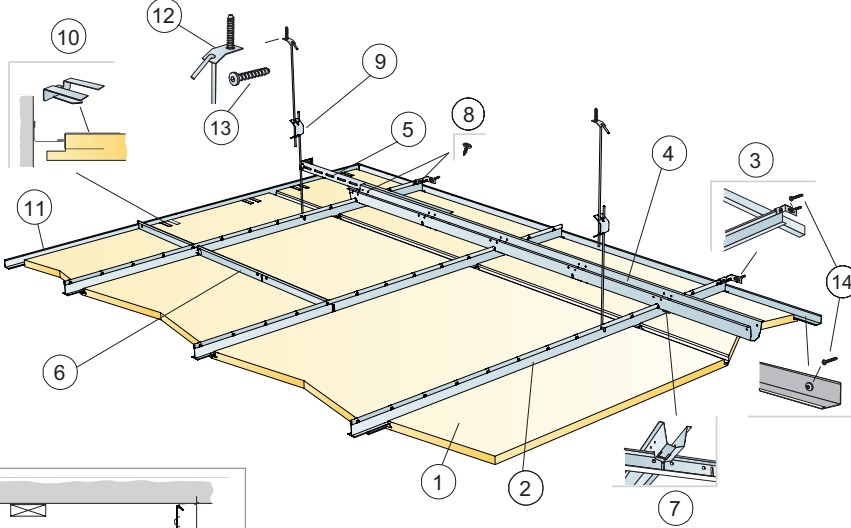

① Ecophon Hygiene Black Ds panel
600x600/1200x600

② Connect T24 Main Runner C4

③ Connect Wall Bracket C4
for T-profiles

④ Connect Space Bar C4

⑤ Connect Wall Bracket C4
for Space Bar

⑥ Connect T24 Cross Tee C4,
L=600/625

⑦ Connect Space Bar Winch C4

⑧ C4 screw for wall brackets
(included in products)

⑨ Connect Adjustable Hanger C4

⑩ Connect Support Clip Dg20 C4

⑪ Connect Angle Trim 15/22 C4, fixed
at c300 mm

⑫ Connect Fixing plate C4

⑬ Connect Anchor Screw C4

⑭ Connect Installation Screw C4

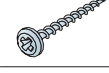
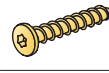
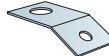
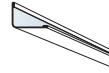
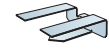
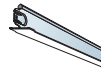
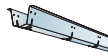
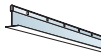

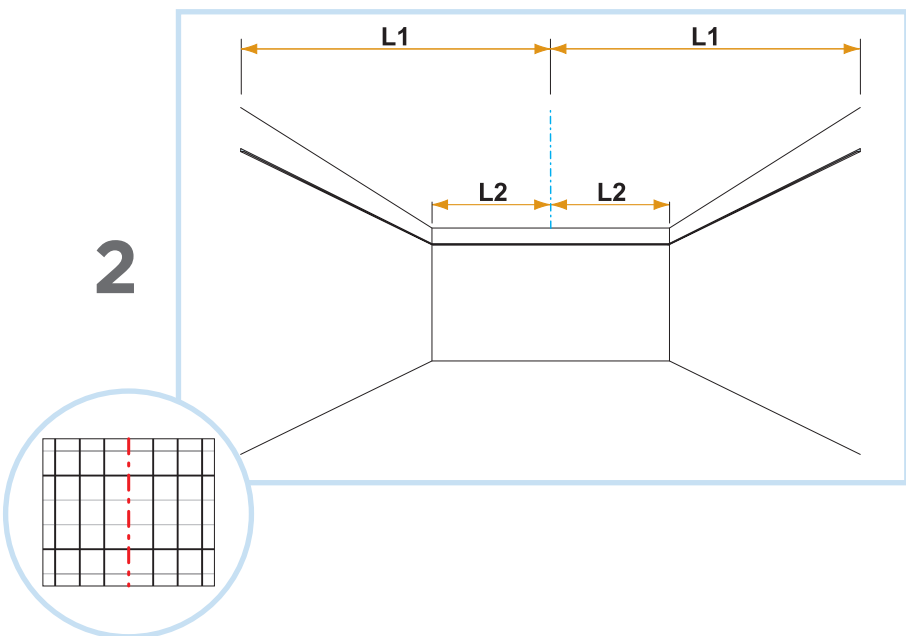
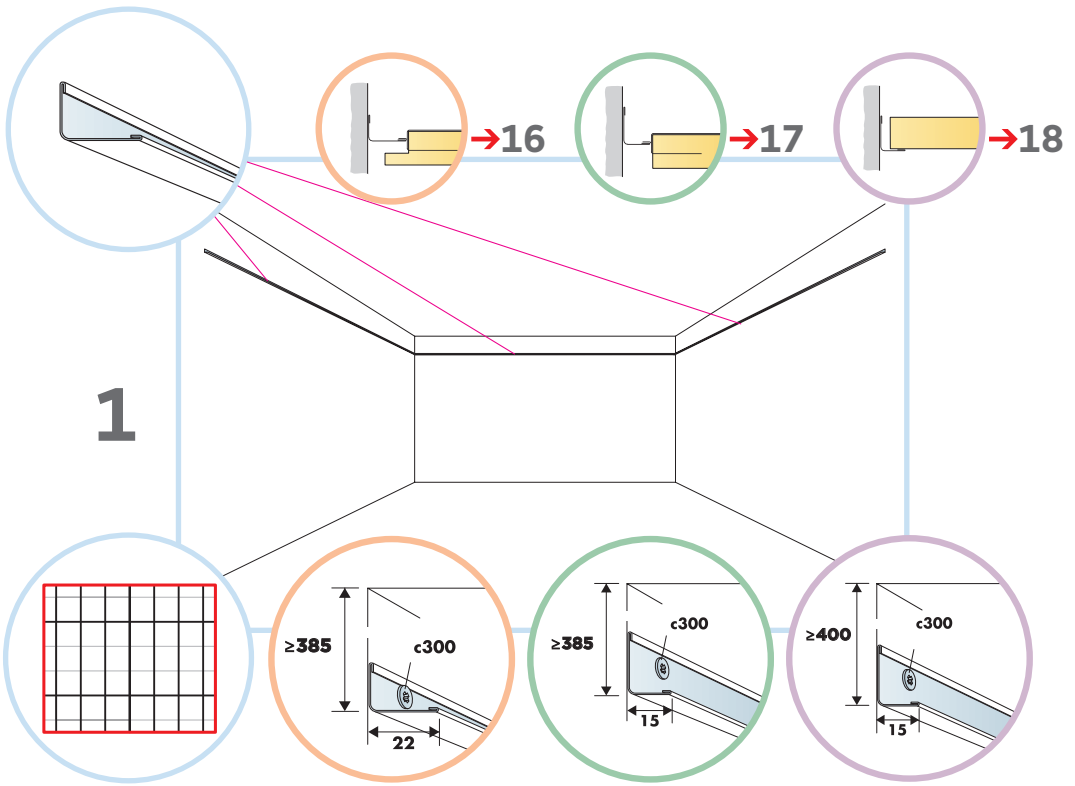

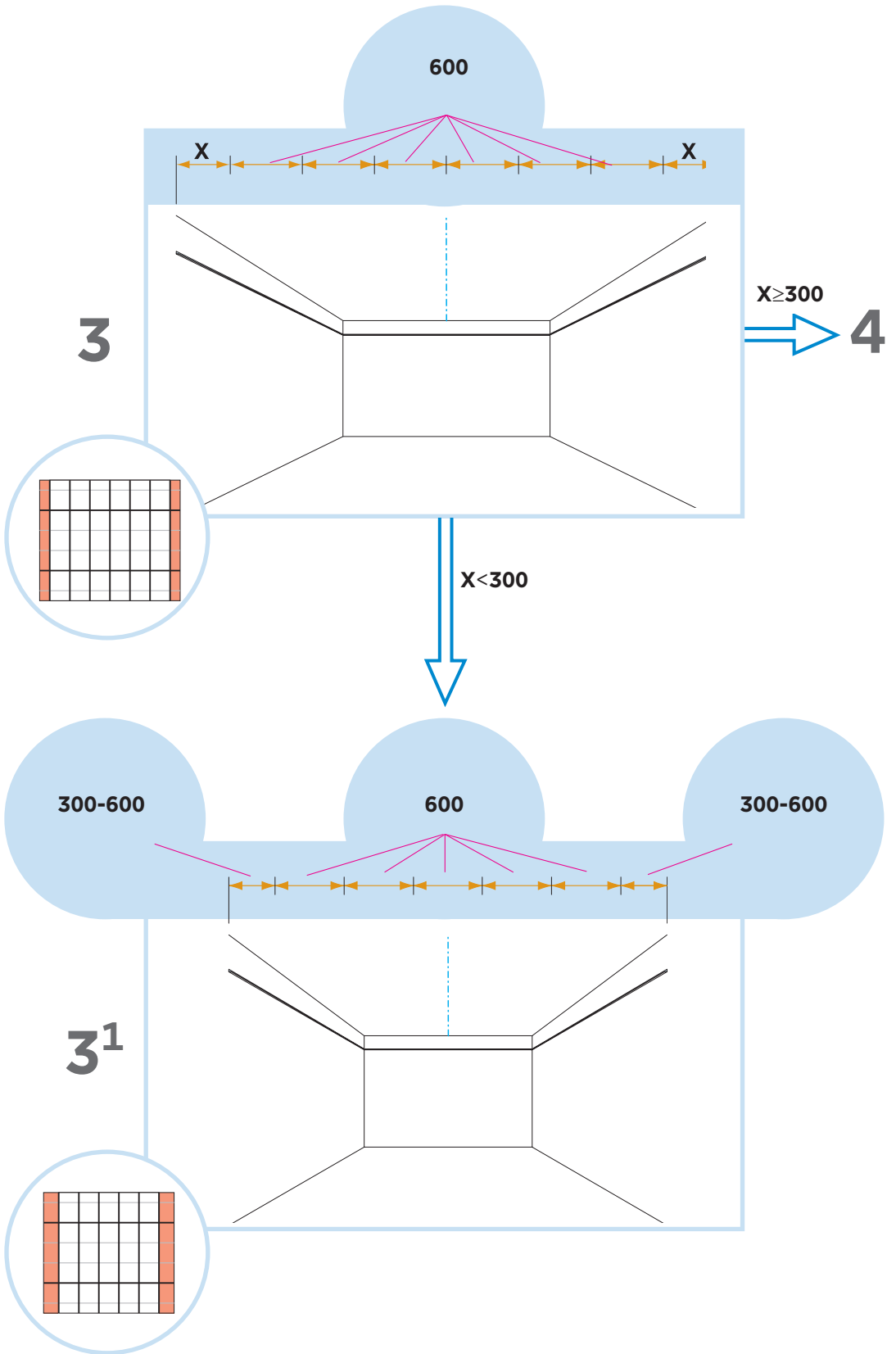

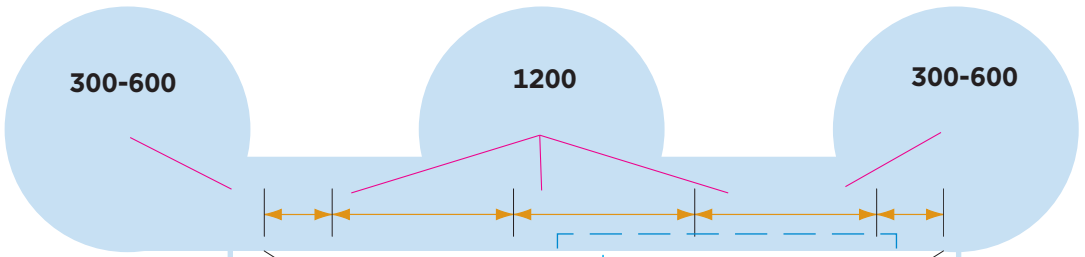

4

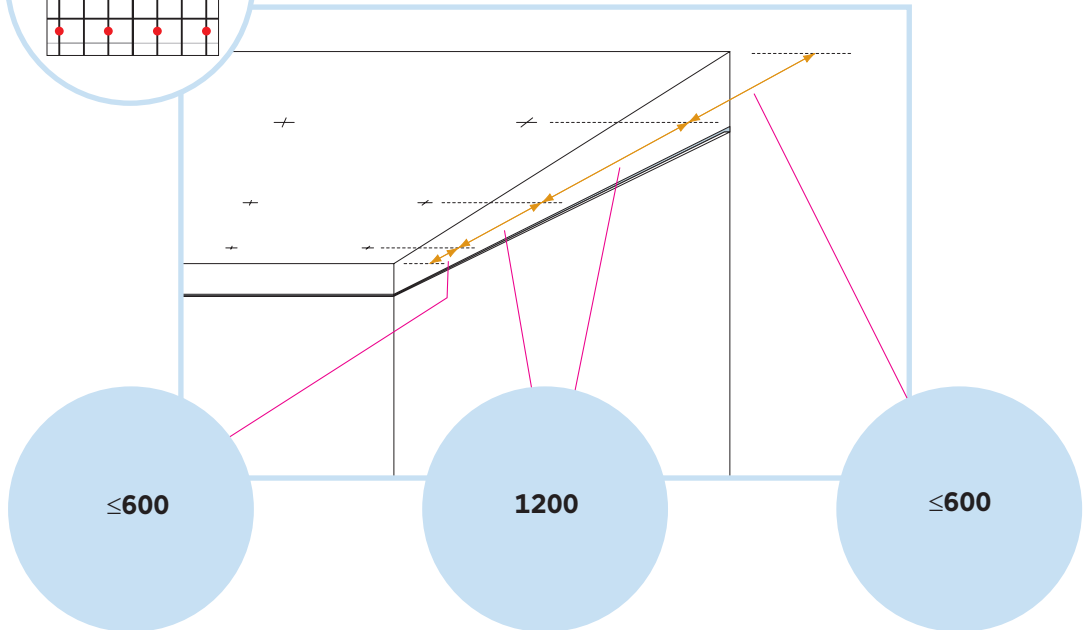
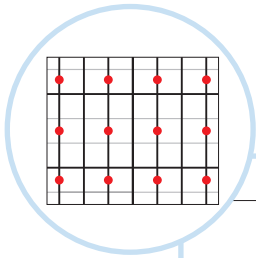
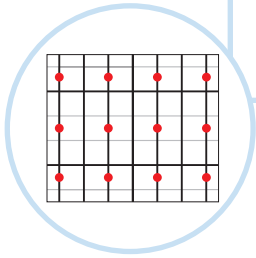

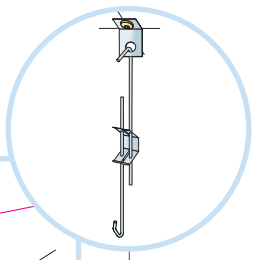
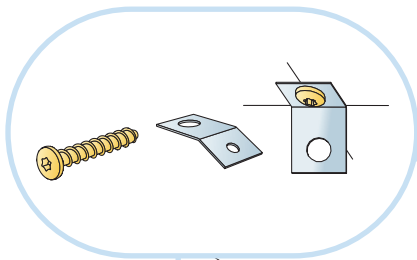

5

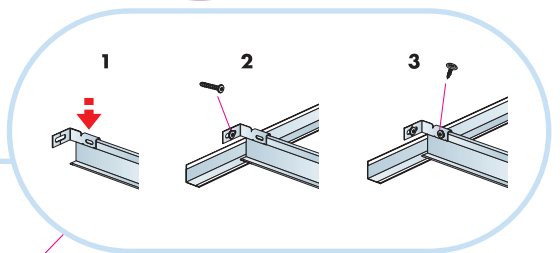
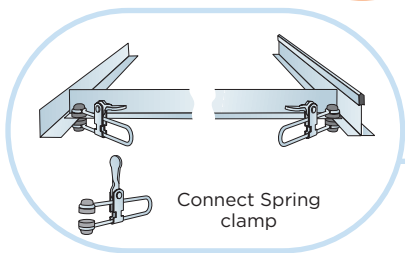
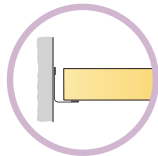
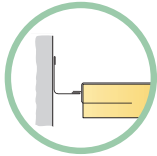
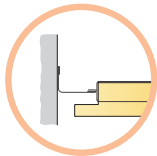
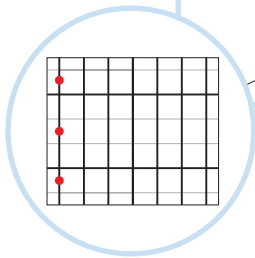
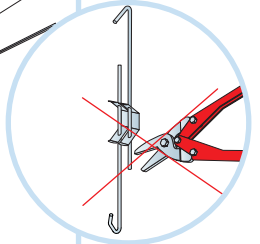
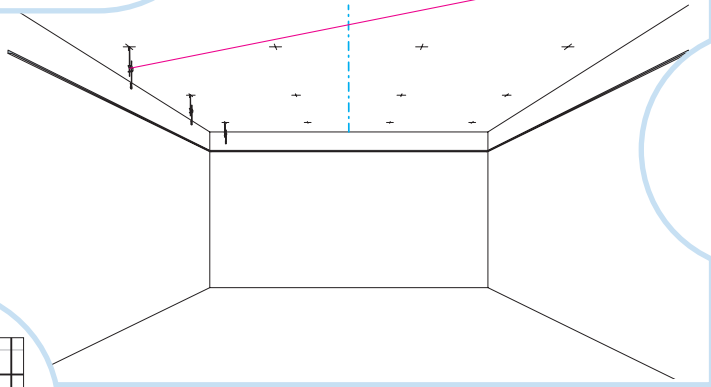

6

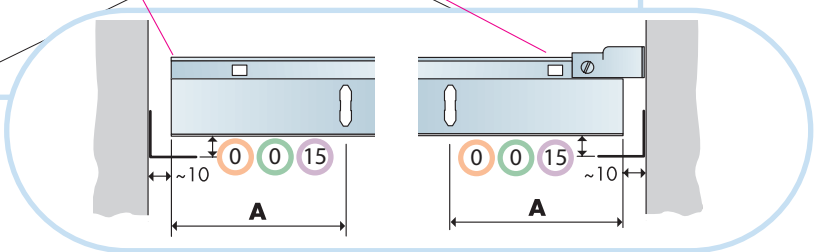
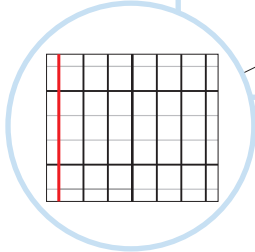
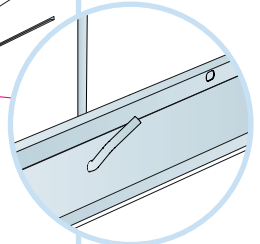
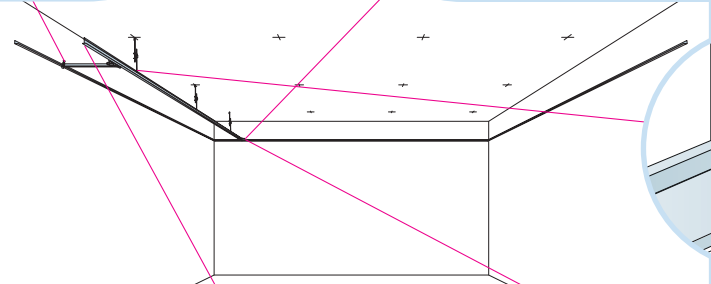

Connect Laser angle

7

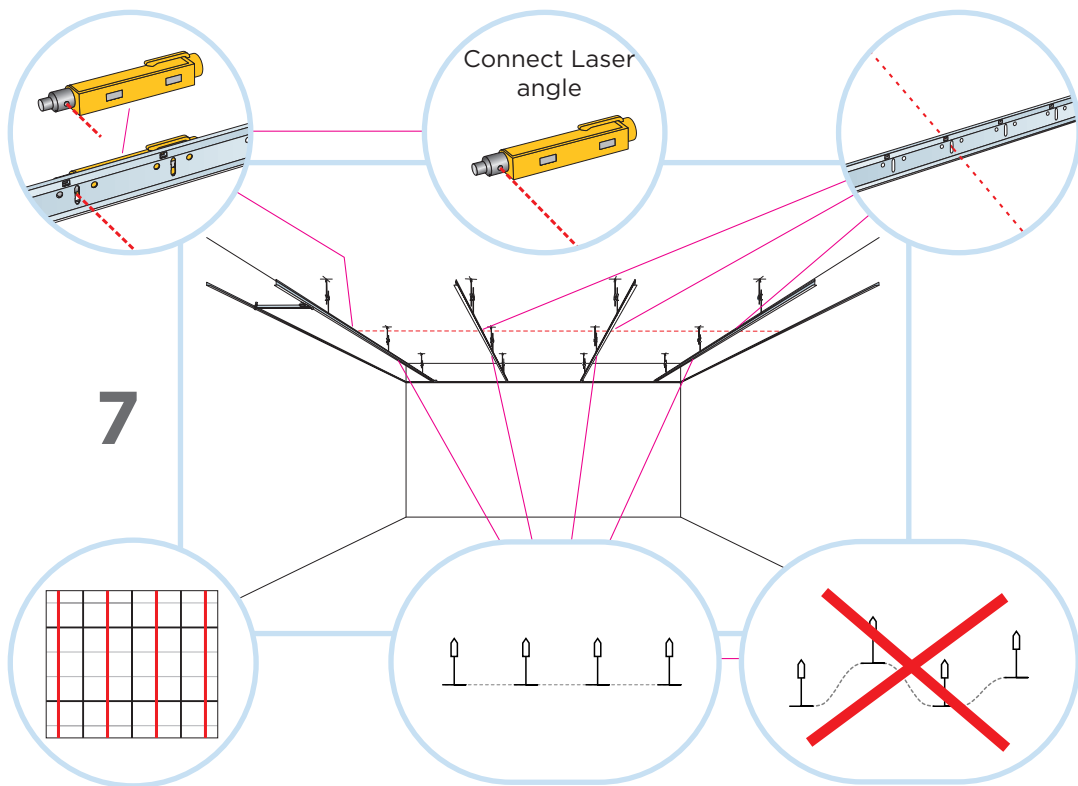

8

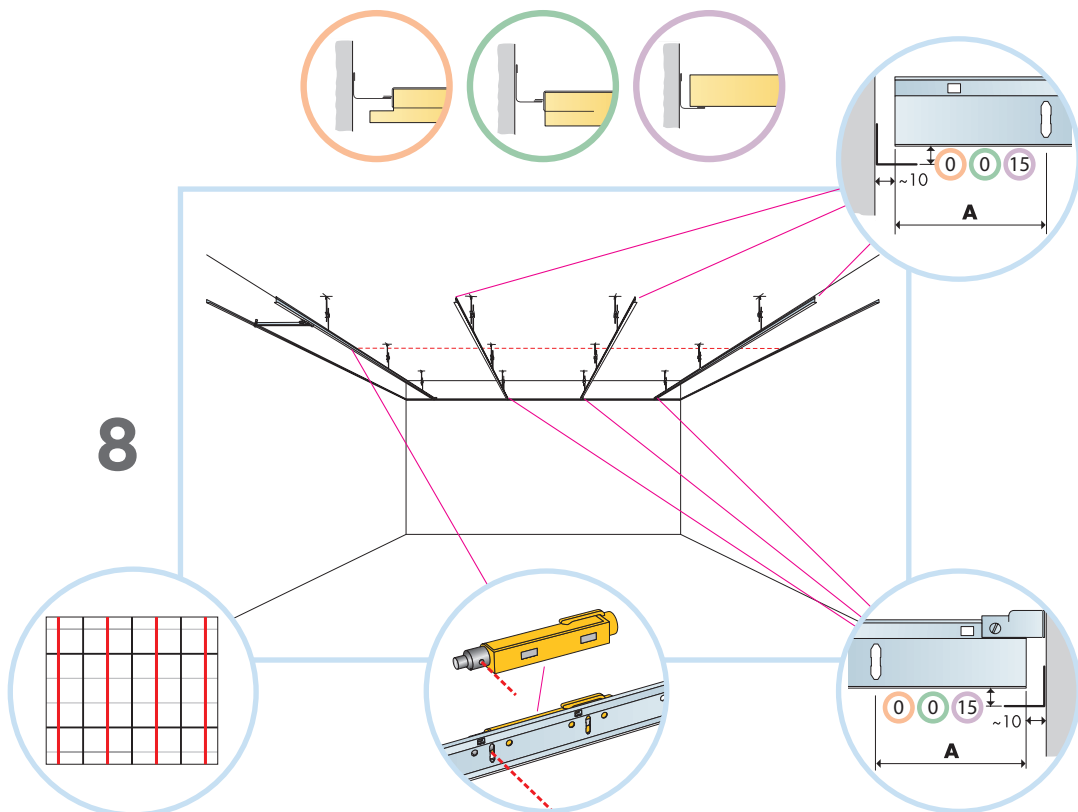

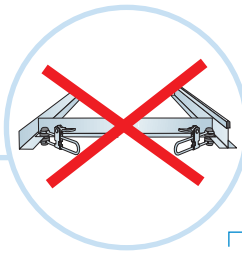
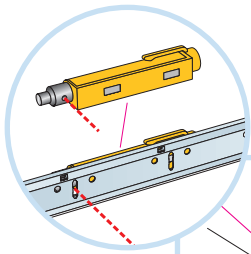

11

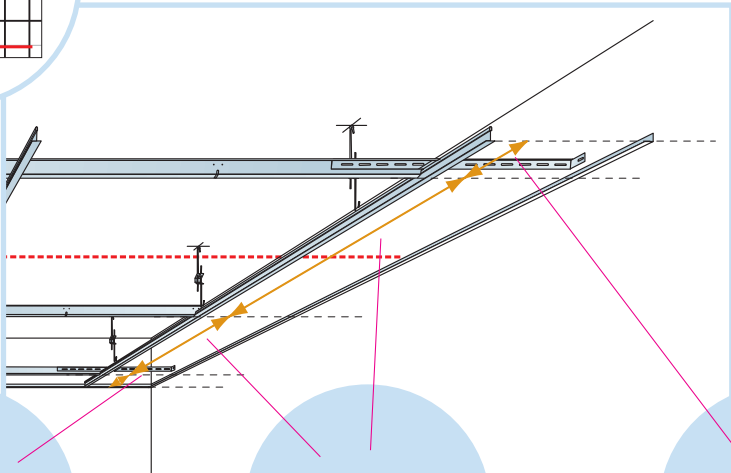
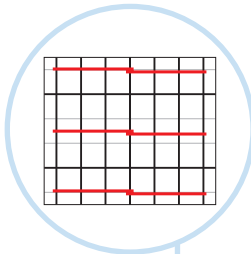
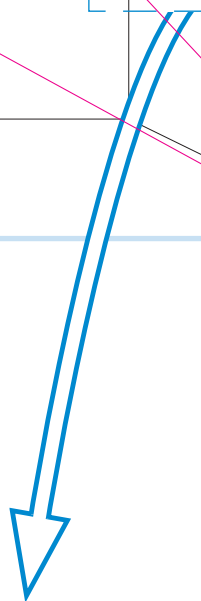
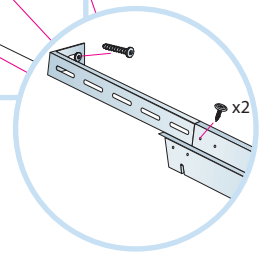
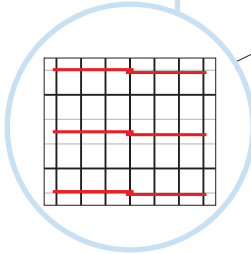

≤300

1500

≤300

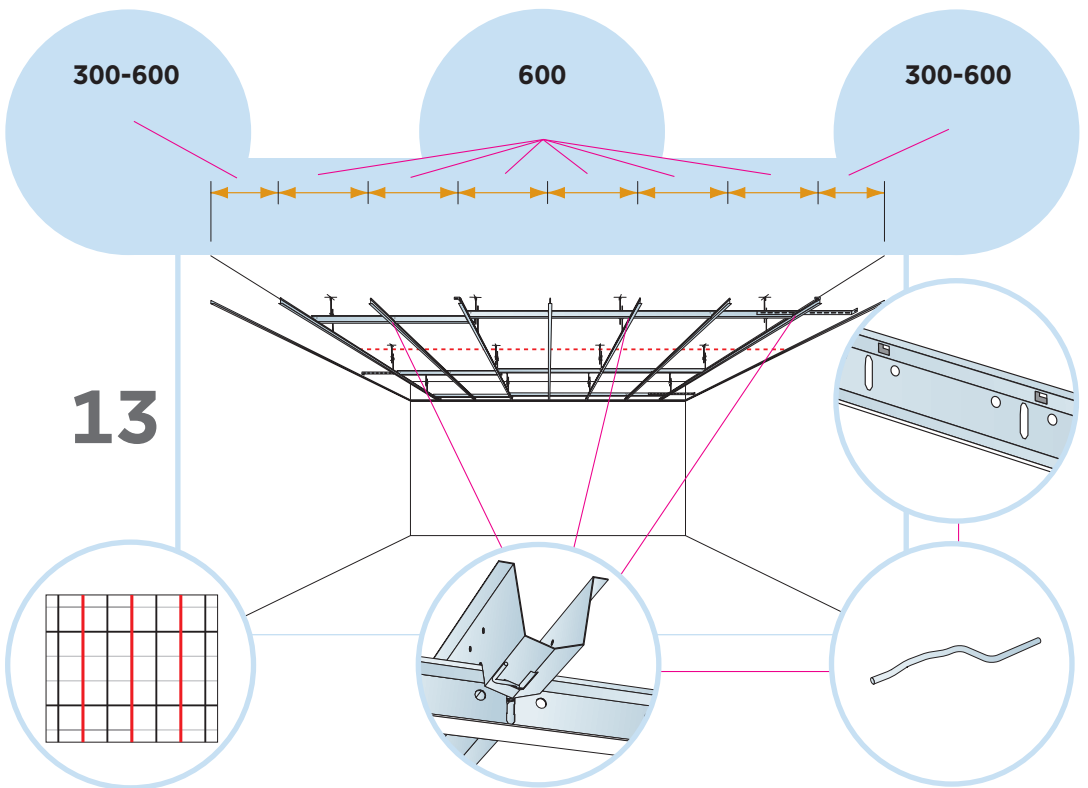
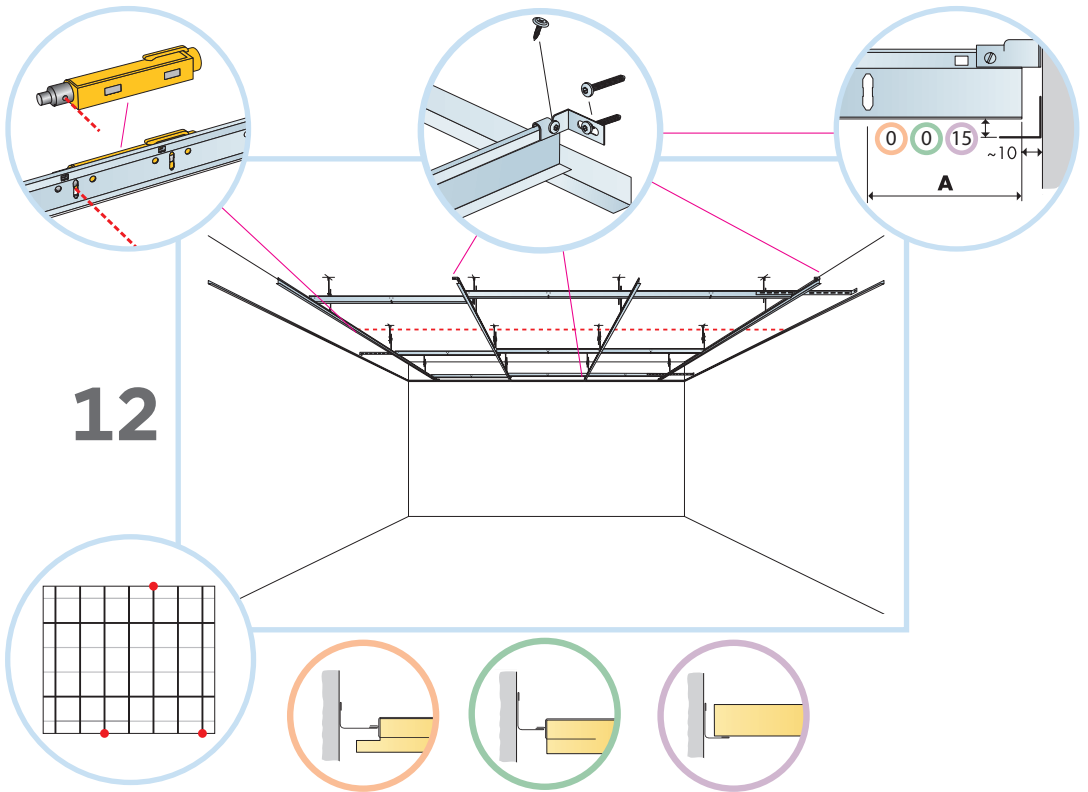

□ 600x600 → 14

□ 1200x600 → 19

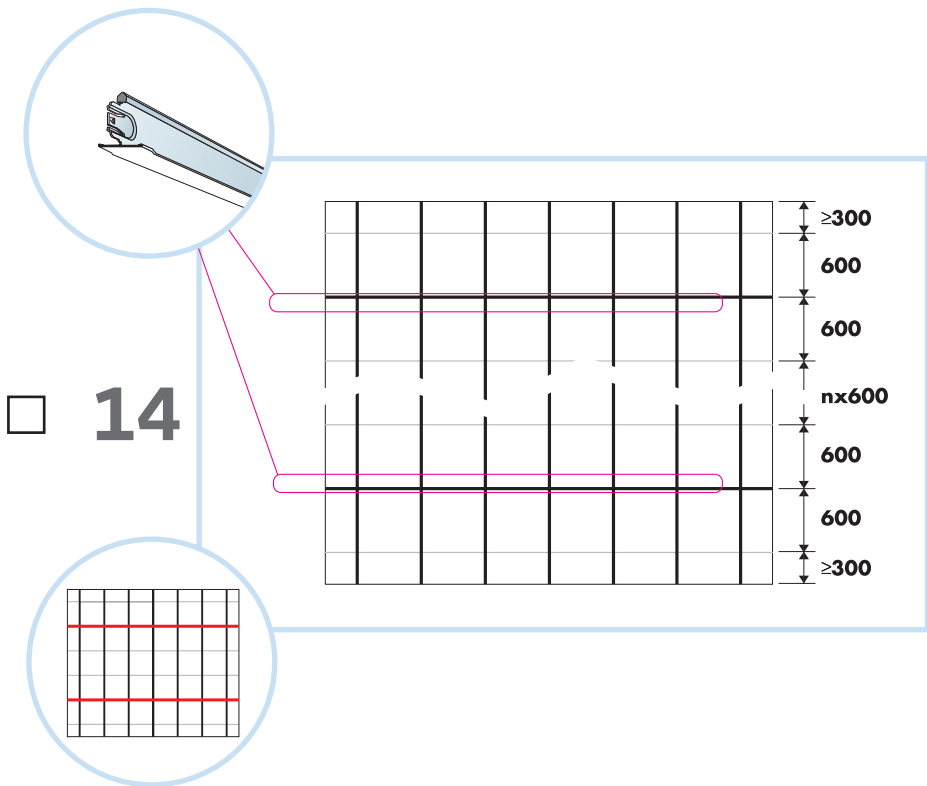

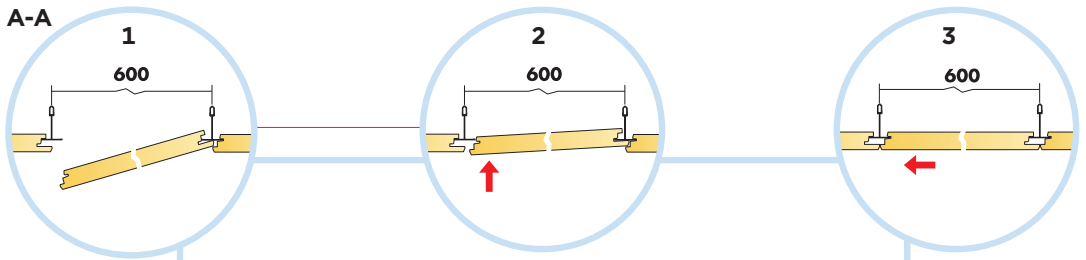

□ 15

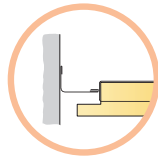
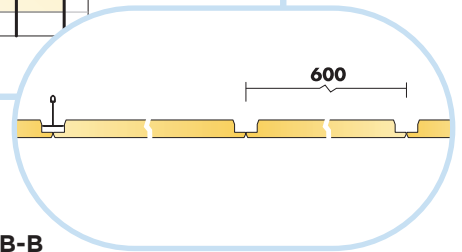
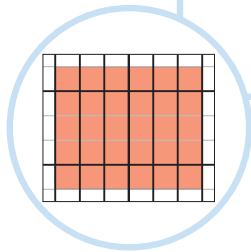
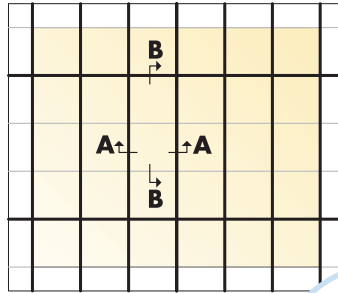

→ 16

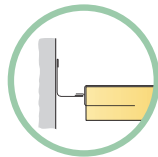

→ 17

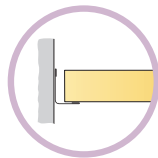

→ 18

Cutting tool 0991

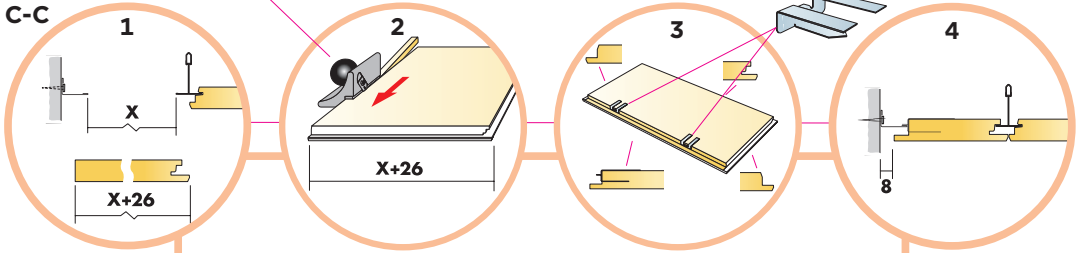

□ 16

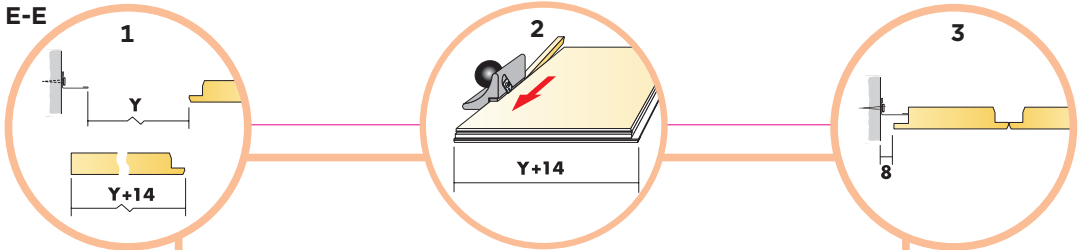
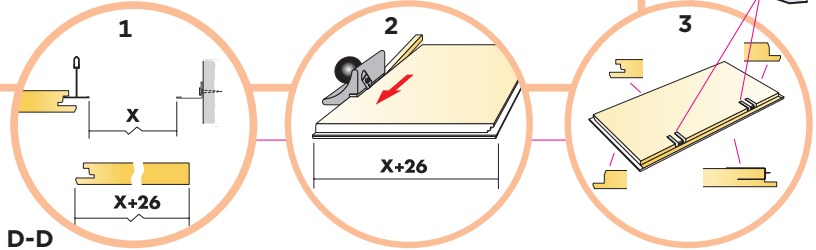
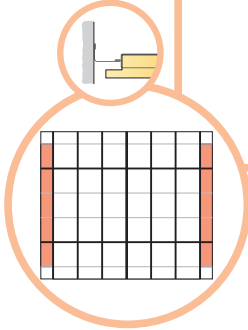
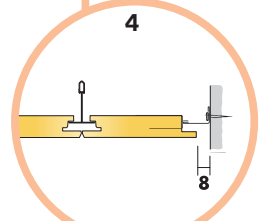
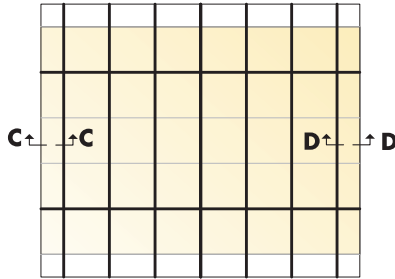

□ 16¹

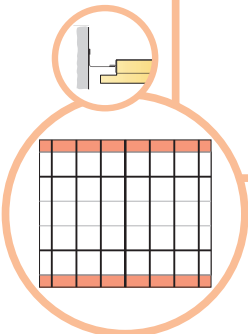
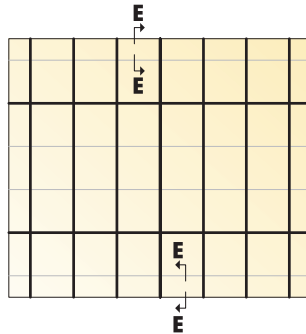

C-C

1

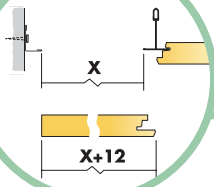

2

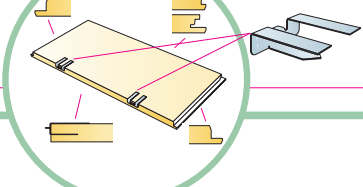

3

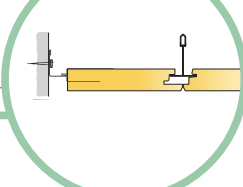

□ 17

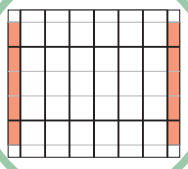
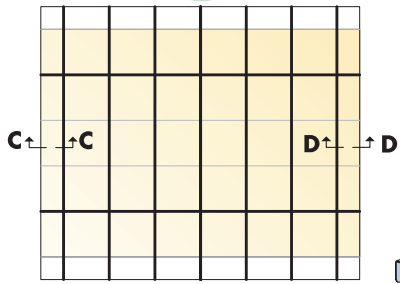

1

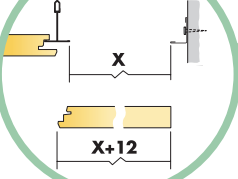

D-D

2

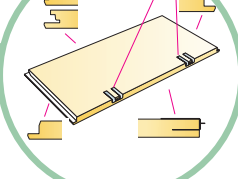

3

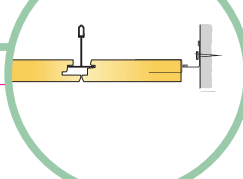

E-E

1

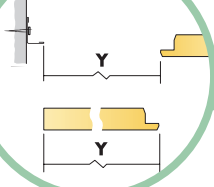

2

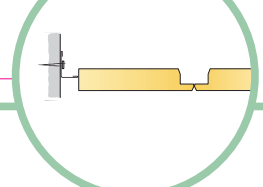

□ 17¹

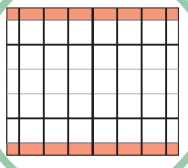
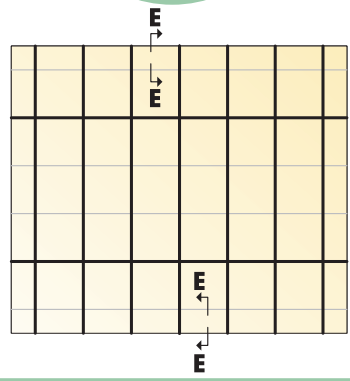

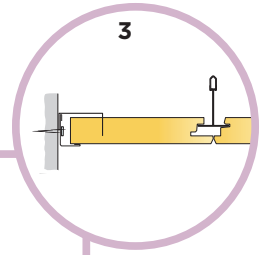
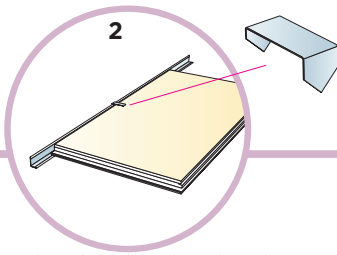
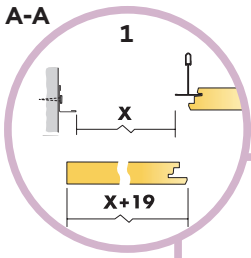

□ **18**

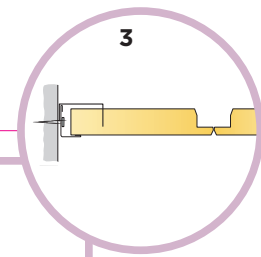
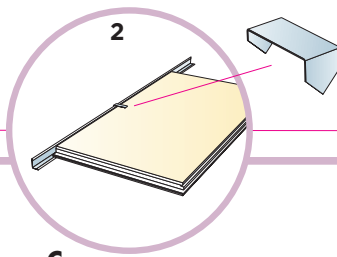
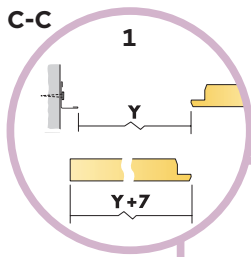
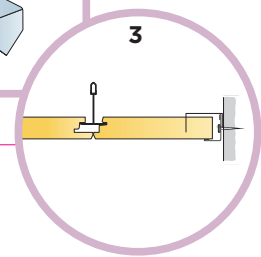
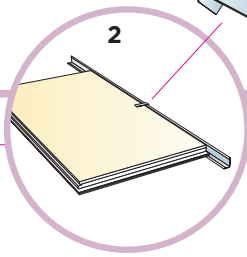
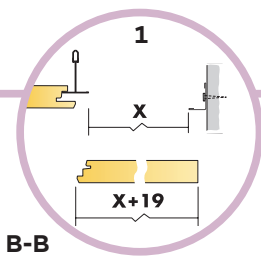
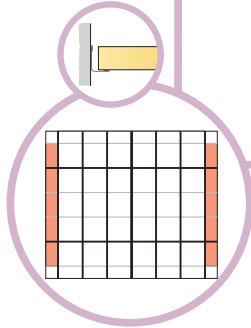
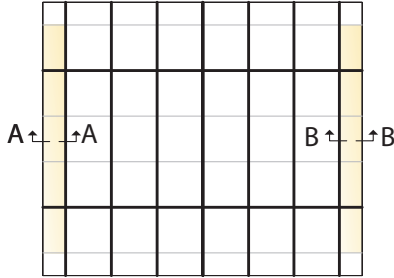

□ **18¹**

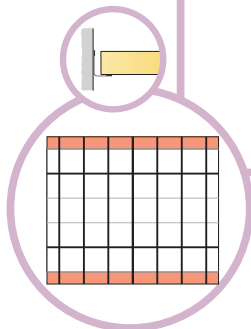
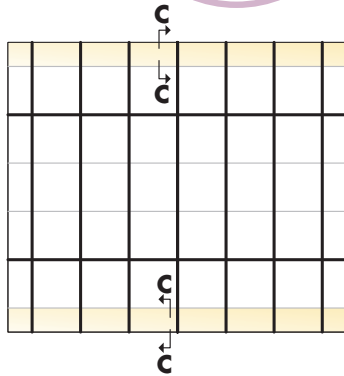

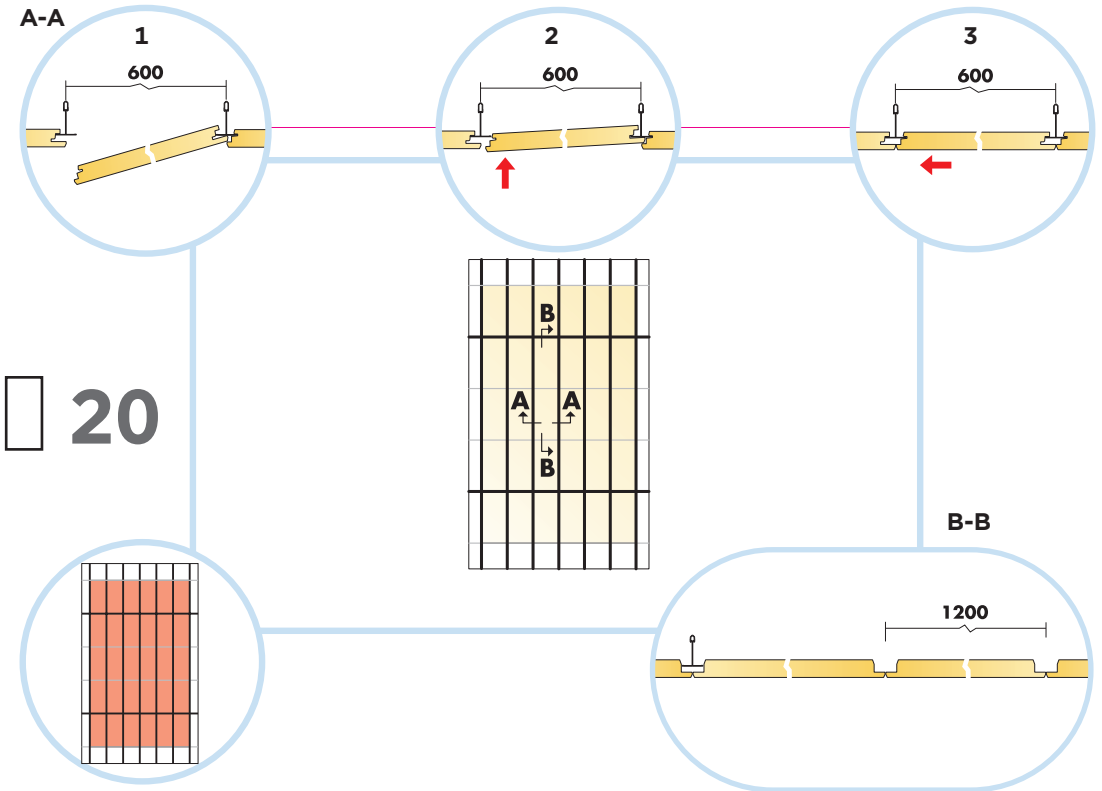
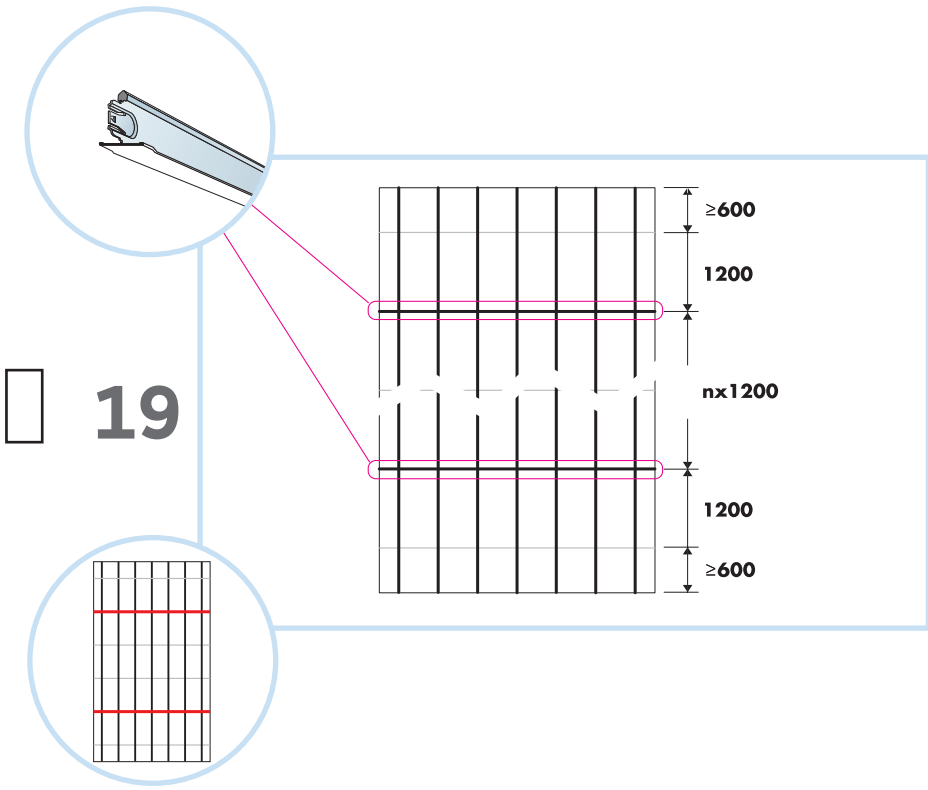

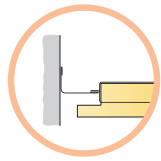

21

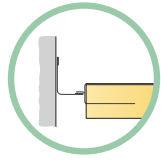

22

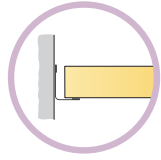

23

Cutting tool 0991

C-C

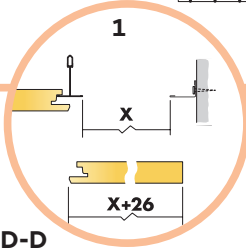
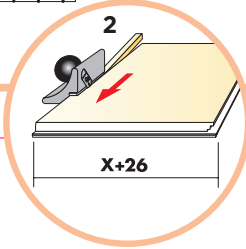
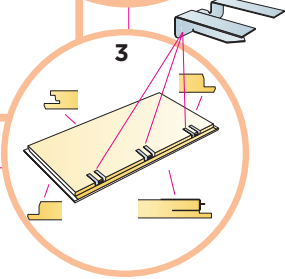
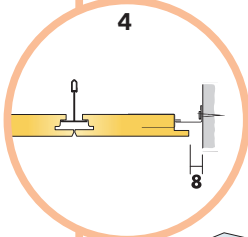
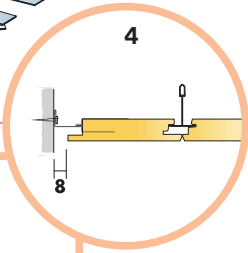
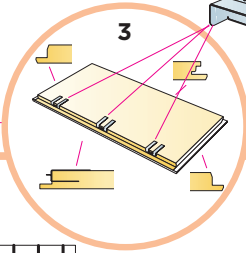
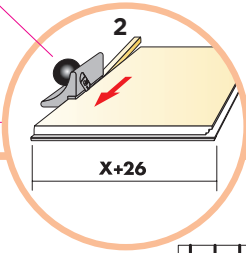
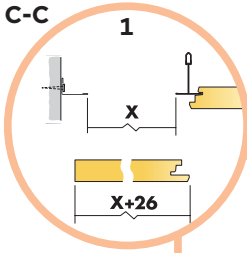

21

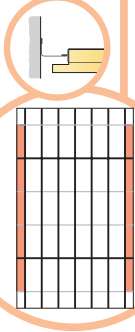
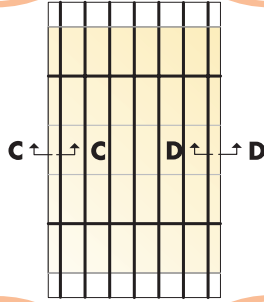

E-E

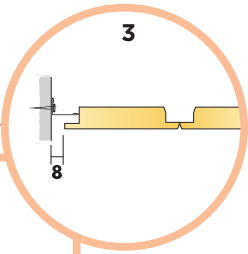
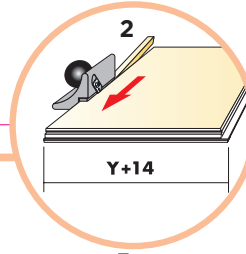
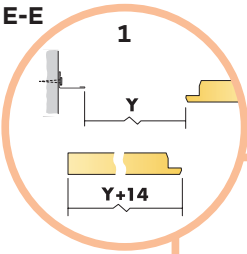

21¹

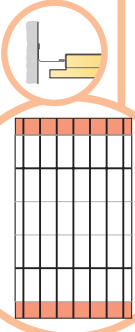
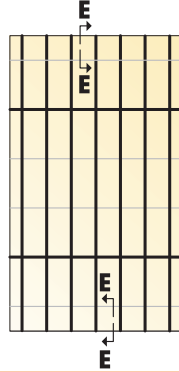

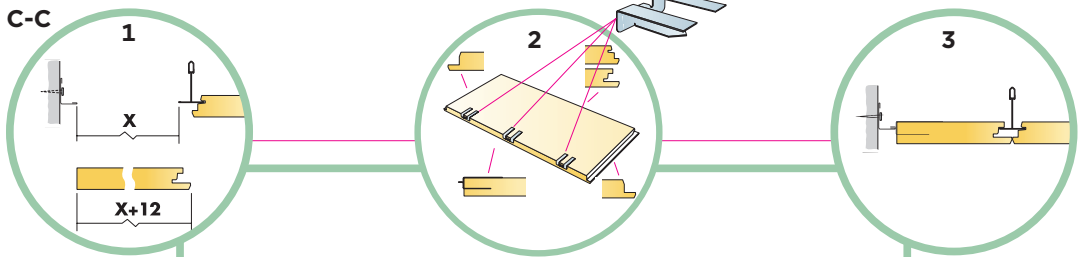

22

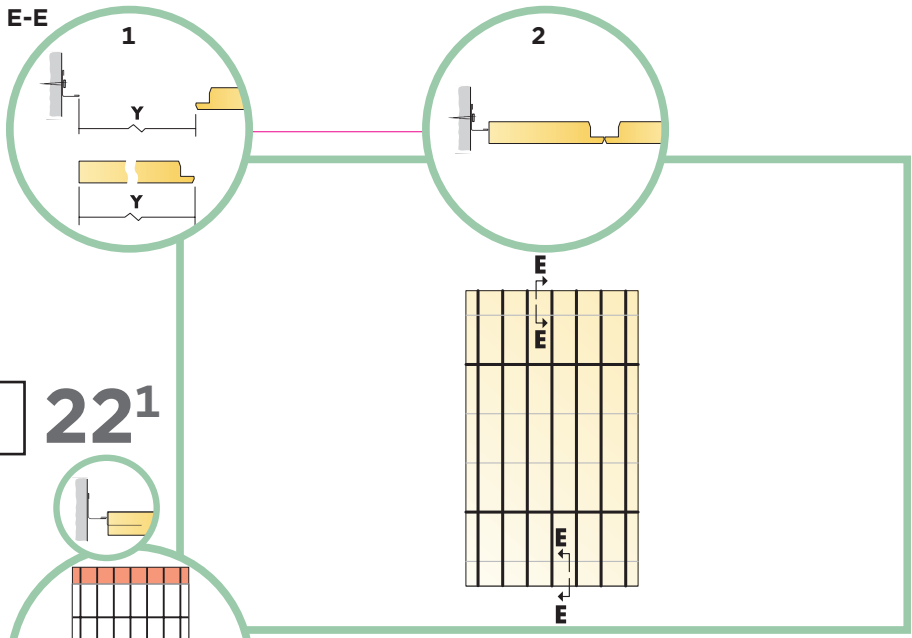
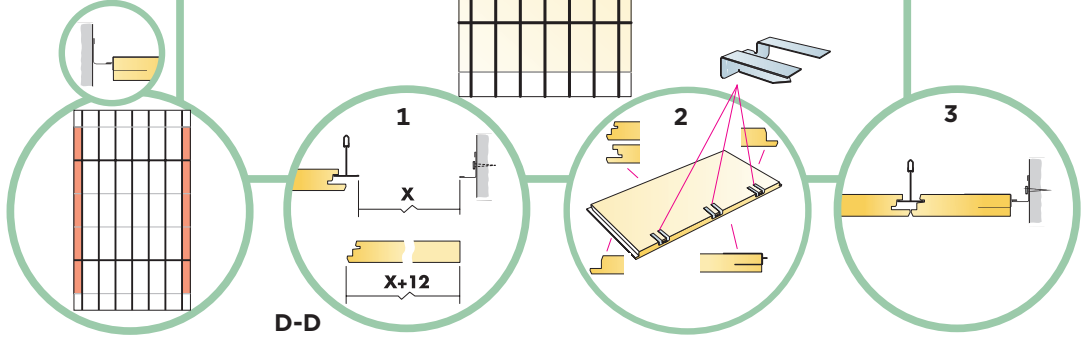
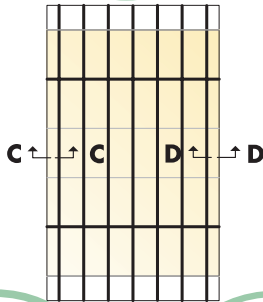

22¹

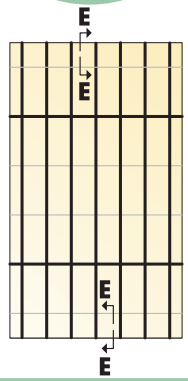

A-A

1

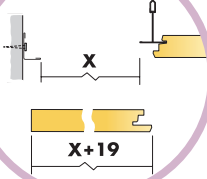

2

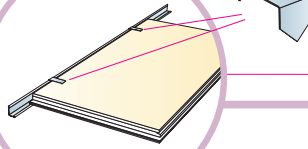

3

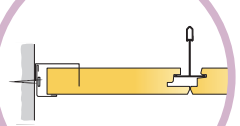

23

A ↑ ↑ A B ↑ ↑ B

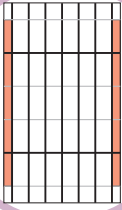
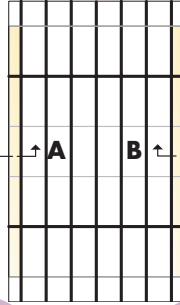

1

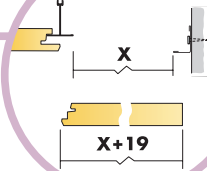

2

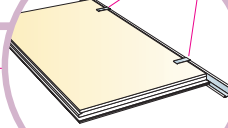

3

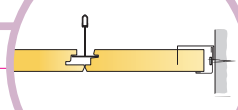

B-B

C-C

1

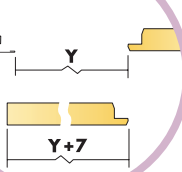

2

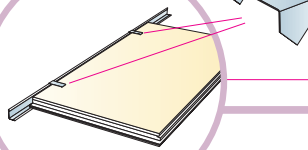

3

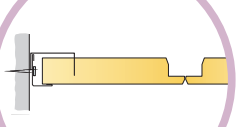

23¹

C ↑ ↑ C

