

Hygiene Performance B

600x600
M638

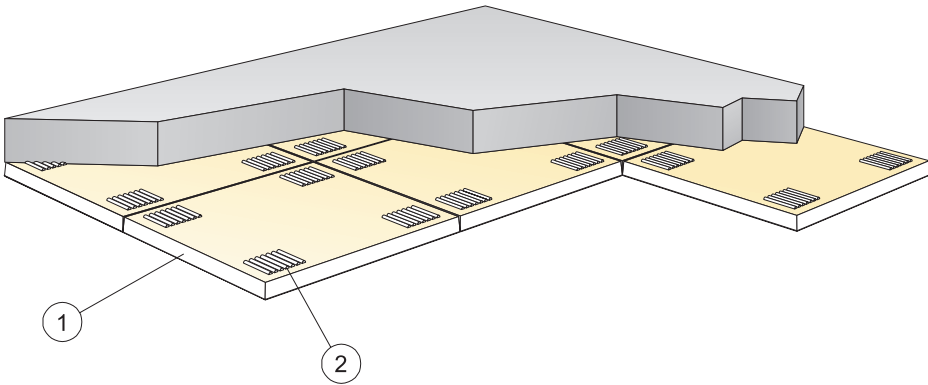
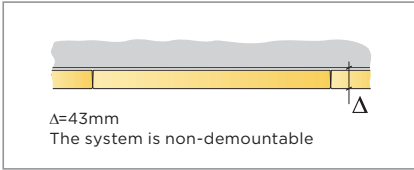

© Saint-Gobain Ecophon AB

1. Ecophon Hygiene Performance™ B

2. Connect Absorber Glue



3. Connect Notched spatula

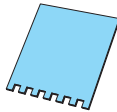

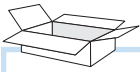

Connect Absorber glue

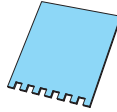

x1

Ensure a smooth, clean, dry strong surface before installation. Suitable surfaces are plasterboard, concrete, light concrete or building board. Avoid surfaces which are sensitive to moisture or water. The surface, the tiles and the glue must be at a temperature of 10-25°C.

In case of doubt or uncertainty, an adhesion test should be carried out prior to the installation. Please contact your Ecophon representative.



Step-by-step installation video available on [ecophon.com](https://www.ecophon.com)

Ecophon
SAINT-GOBAIN

www.ecophon.com

1

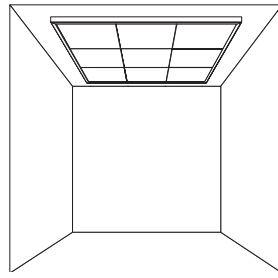
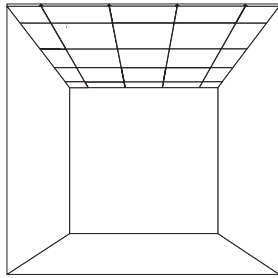

2



10

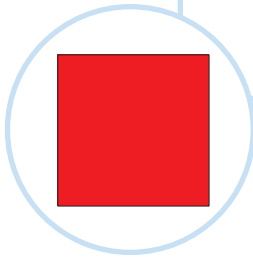

2

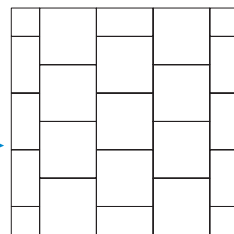
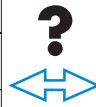
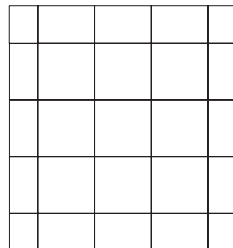
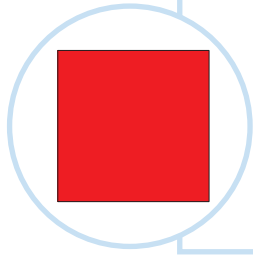
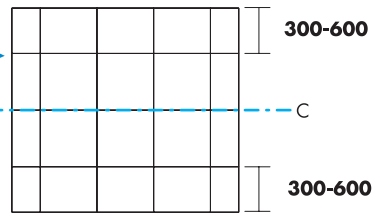
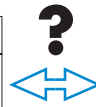
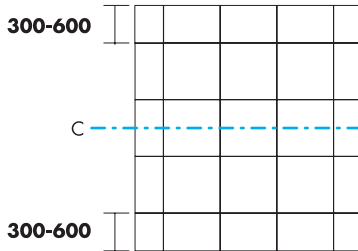

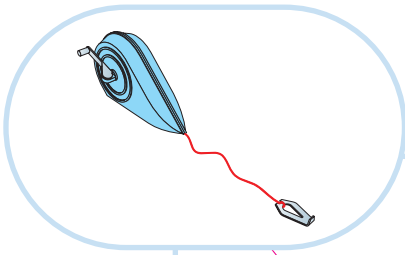

3

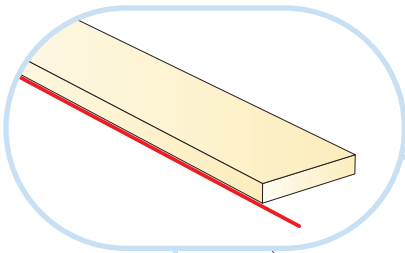
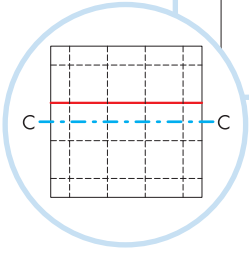
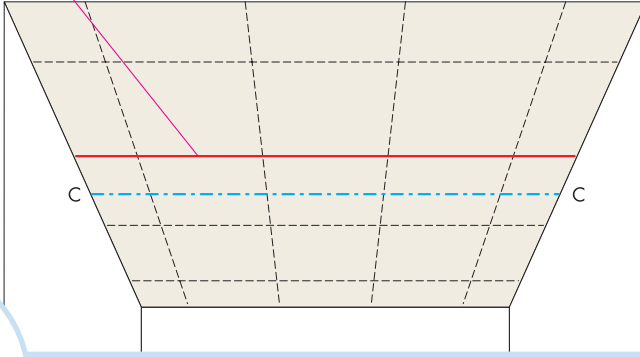

4

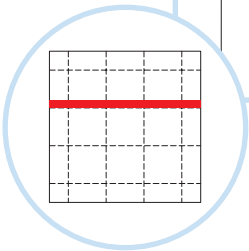
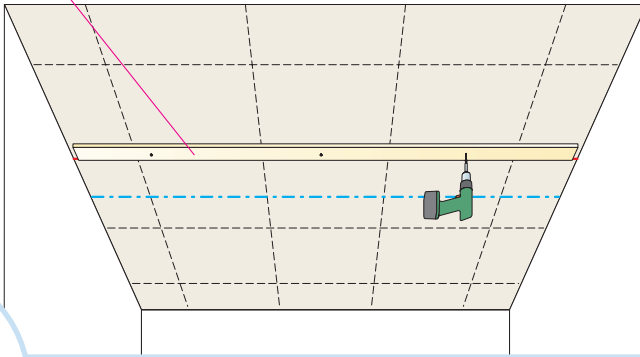

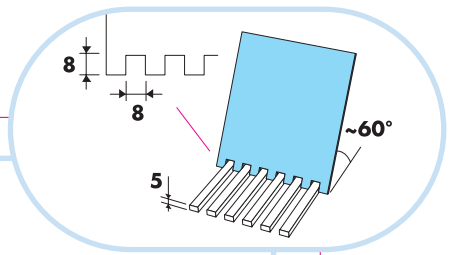
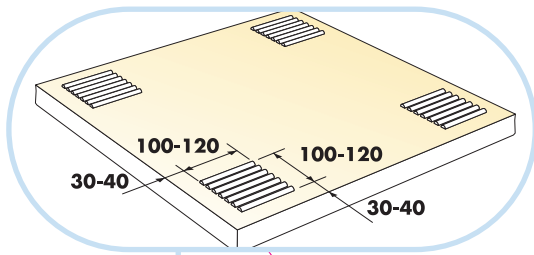

5

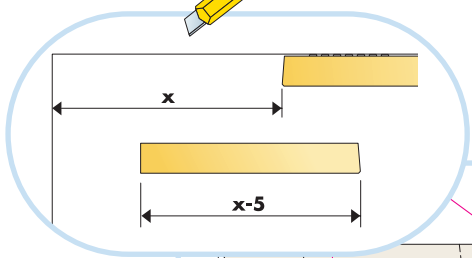
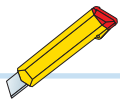
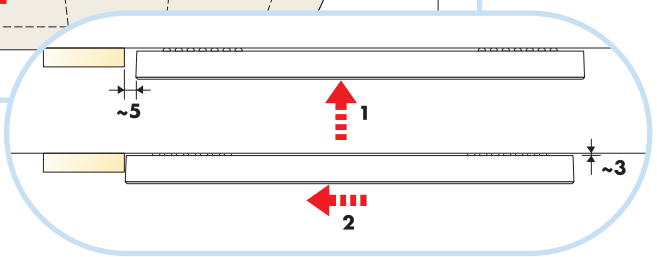
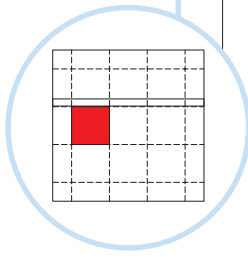
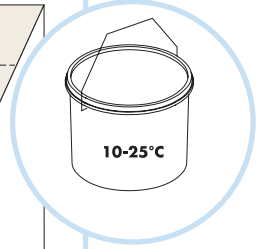
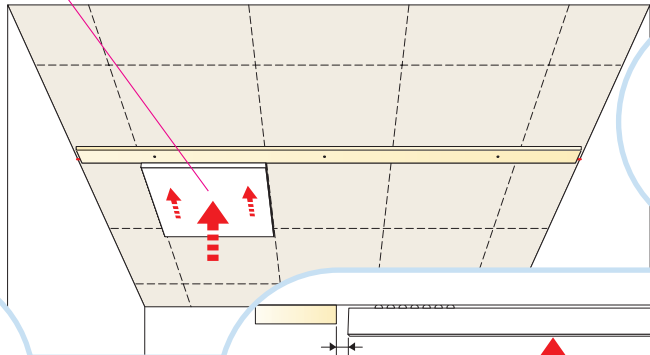

6

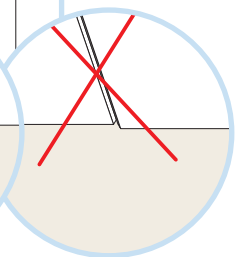
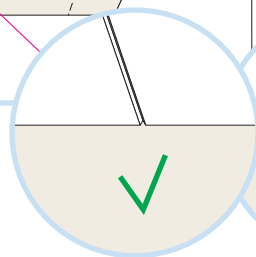
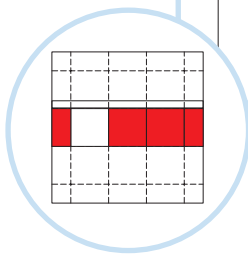
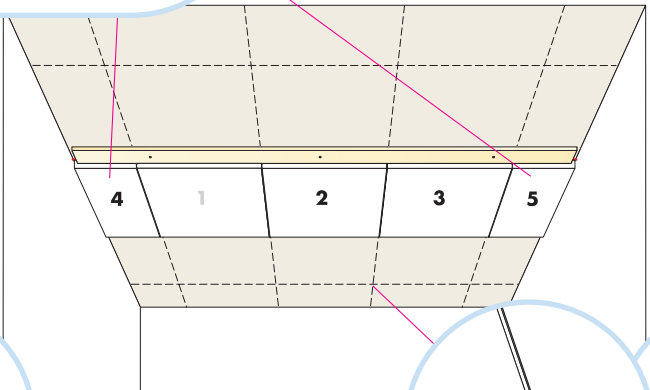

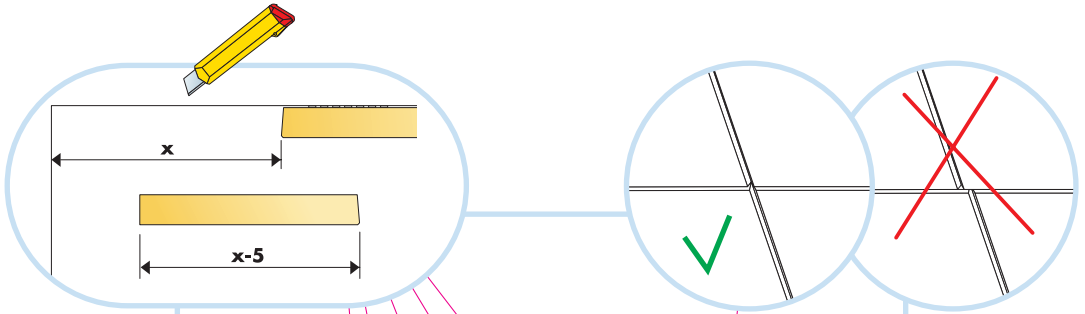

7

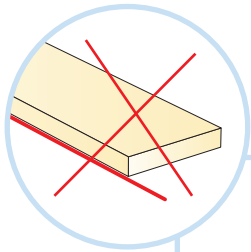
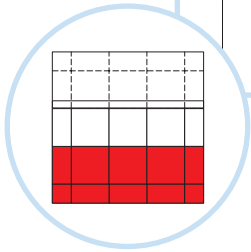
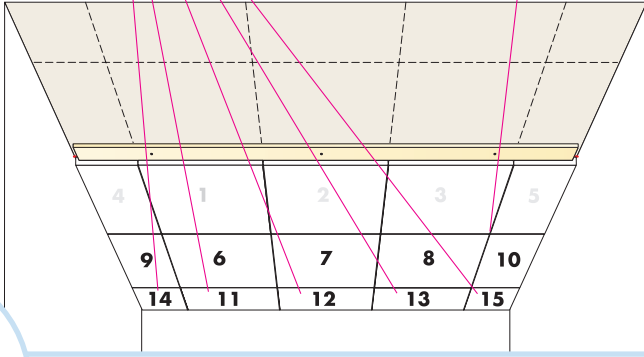

8

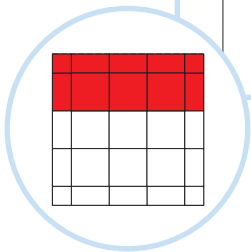
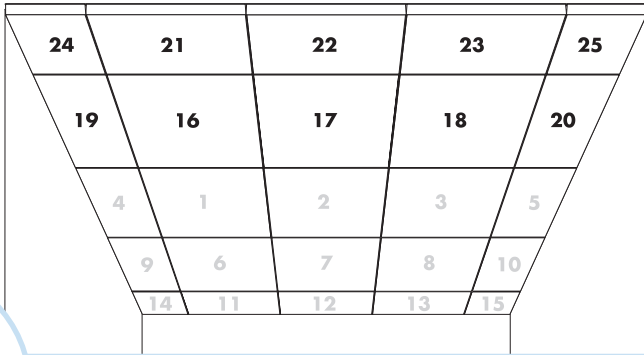

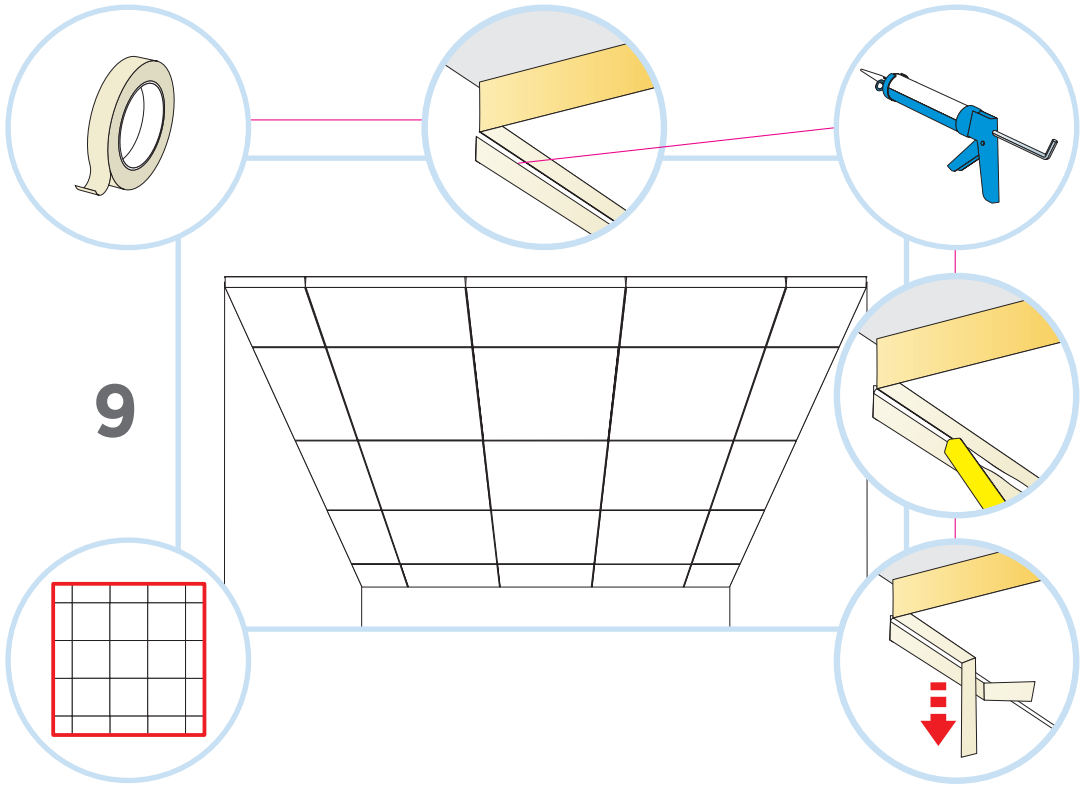

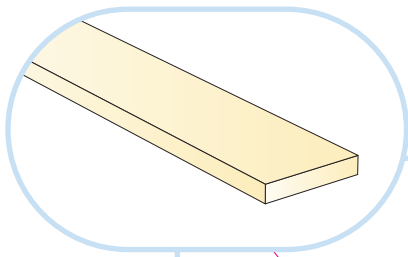

10

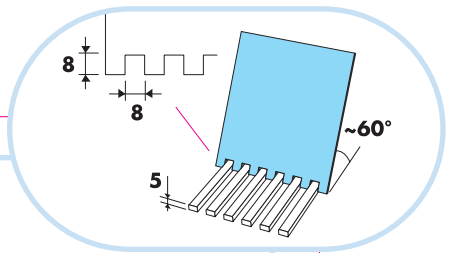
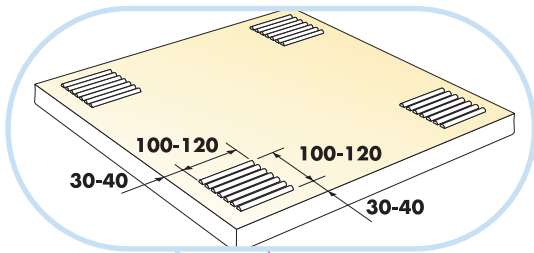
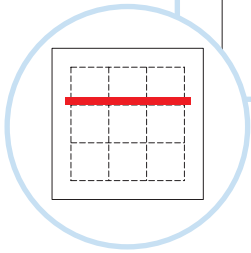
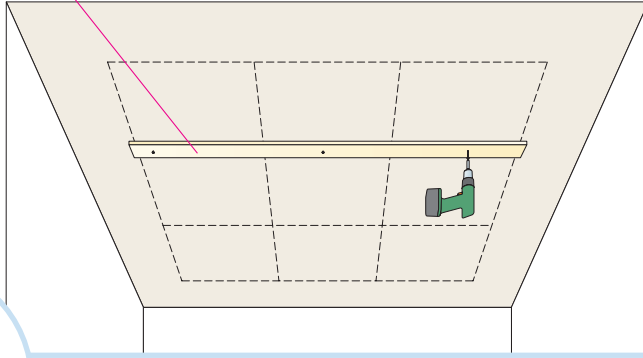

11

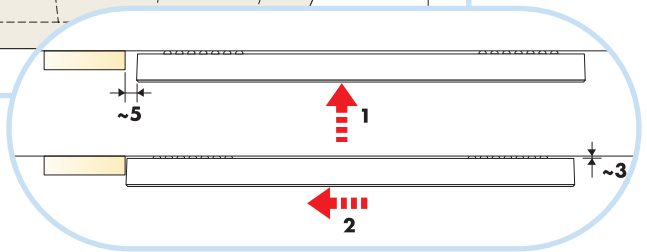
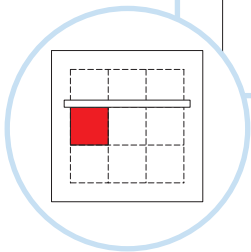
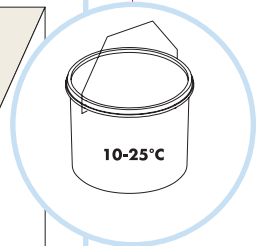
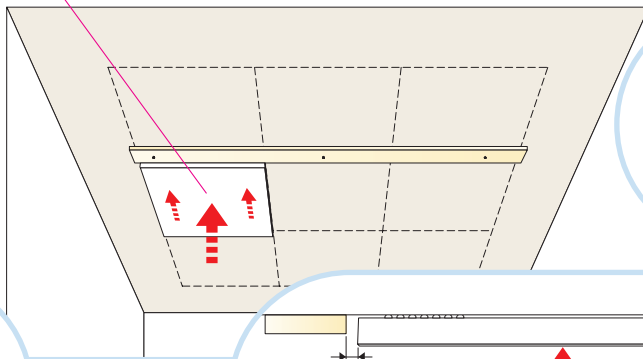

12

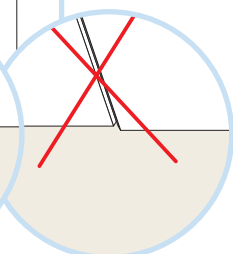
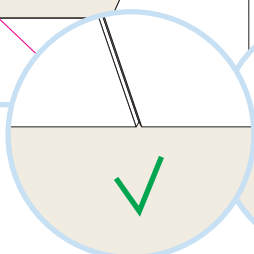
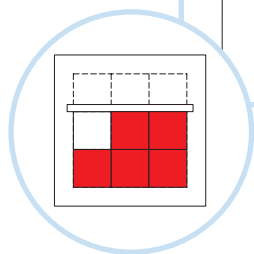
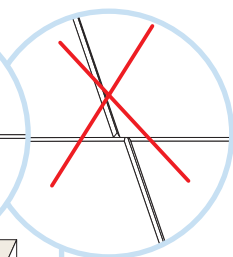
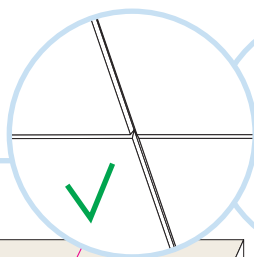
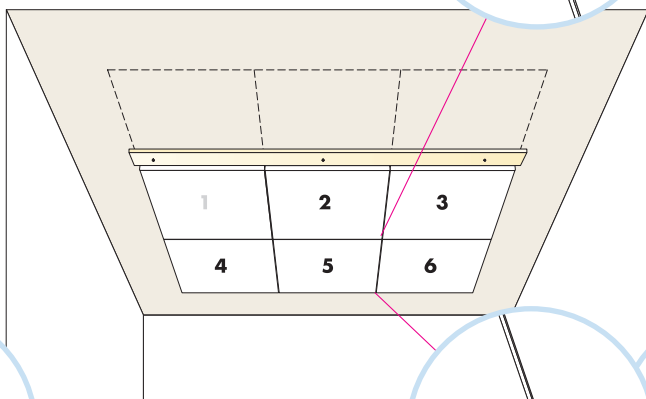

13

