

# Ecophon Hygiene Performance™ Ds

600x600, 1200x600, 625x625

## IG616C4

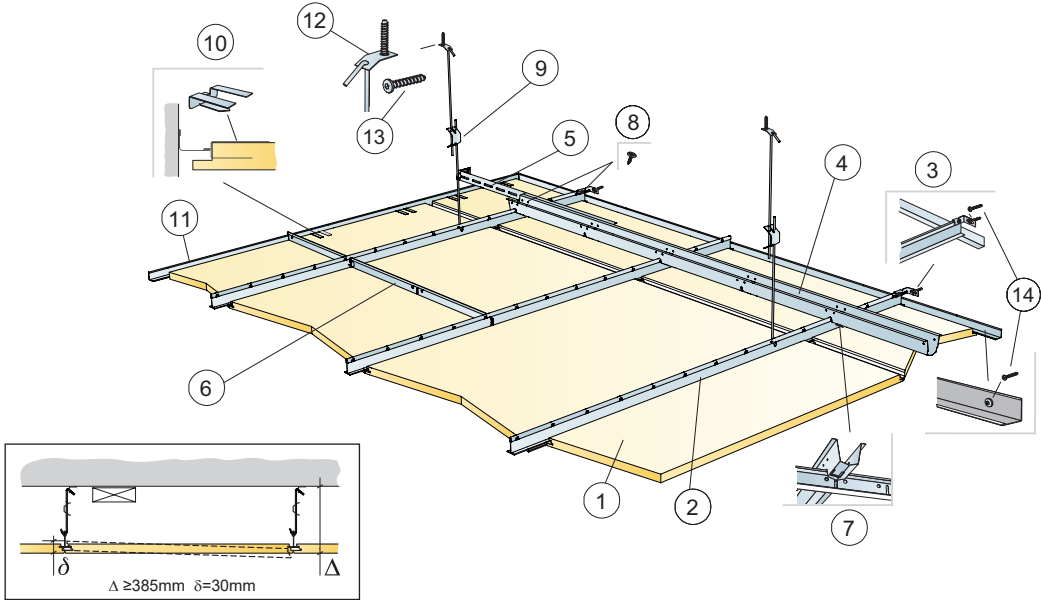

1. Performance Ds

2. Connect T24 Main Runner C4

3. Connect Wall Bracket C4 for T-profiles

4. Connect Space Bar C4

5. Connect Wall Bracket C4 for Space Bar

6. Connect T24 Cross Tee C4, L=600/625

7. Connect Space Bar Winch C4

8. C4 screw for wall brackets (included in products)

9. Connect Adjustable Hanger C4

10. Connect Support Clip Dg20 C4

11. Connect Angle Trim 15/22 C4, fixed at c300 mm

12. Connect Fixing plate C4

13. Connect Anchor Screw C4

14. Connect Installation Screw C4

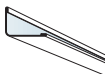
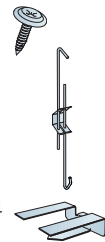
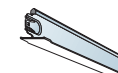
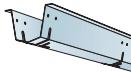
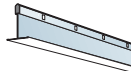

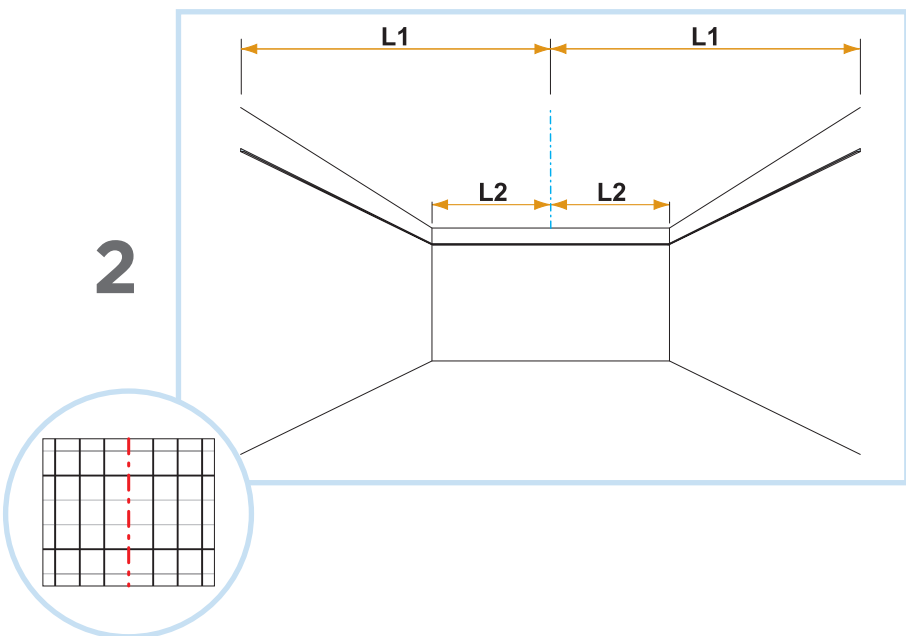
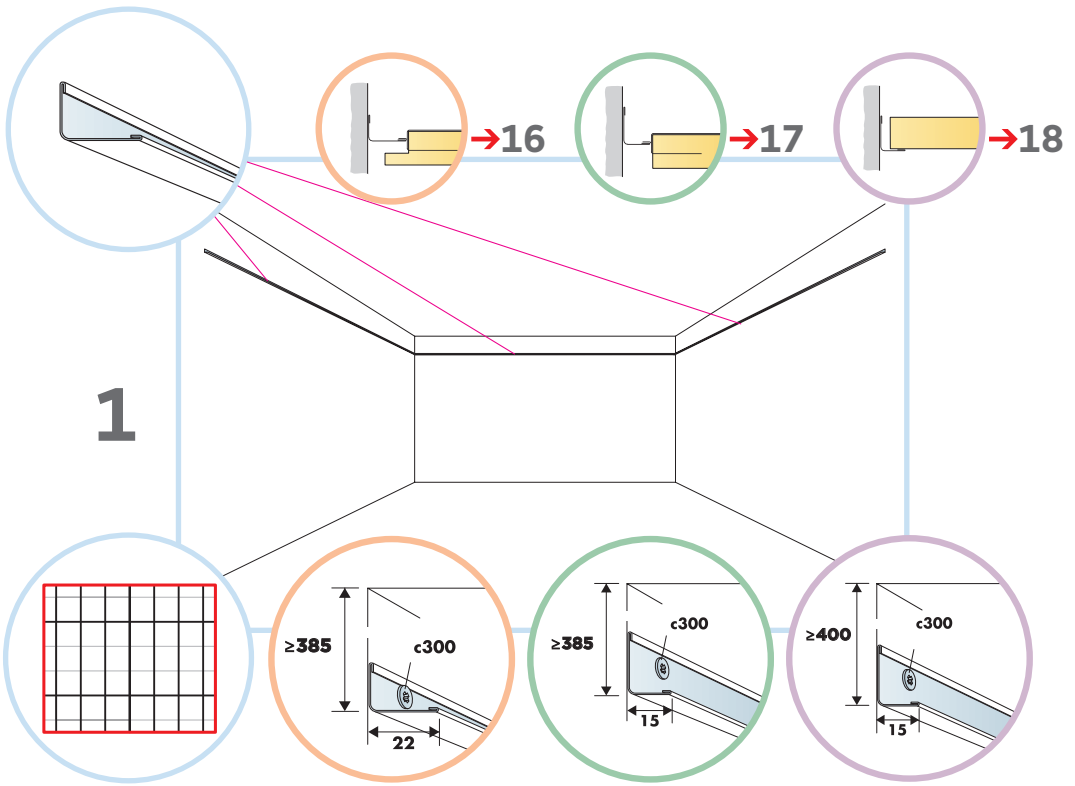

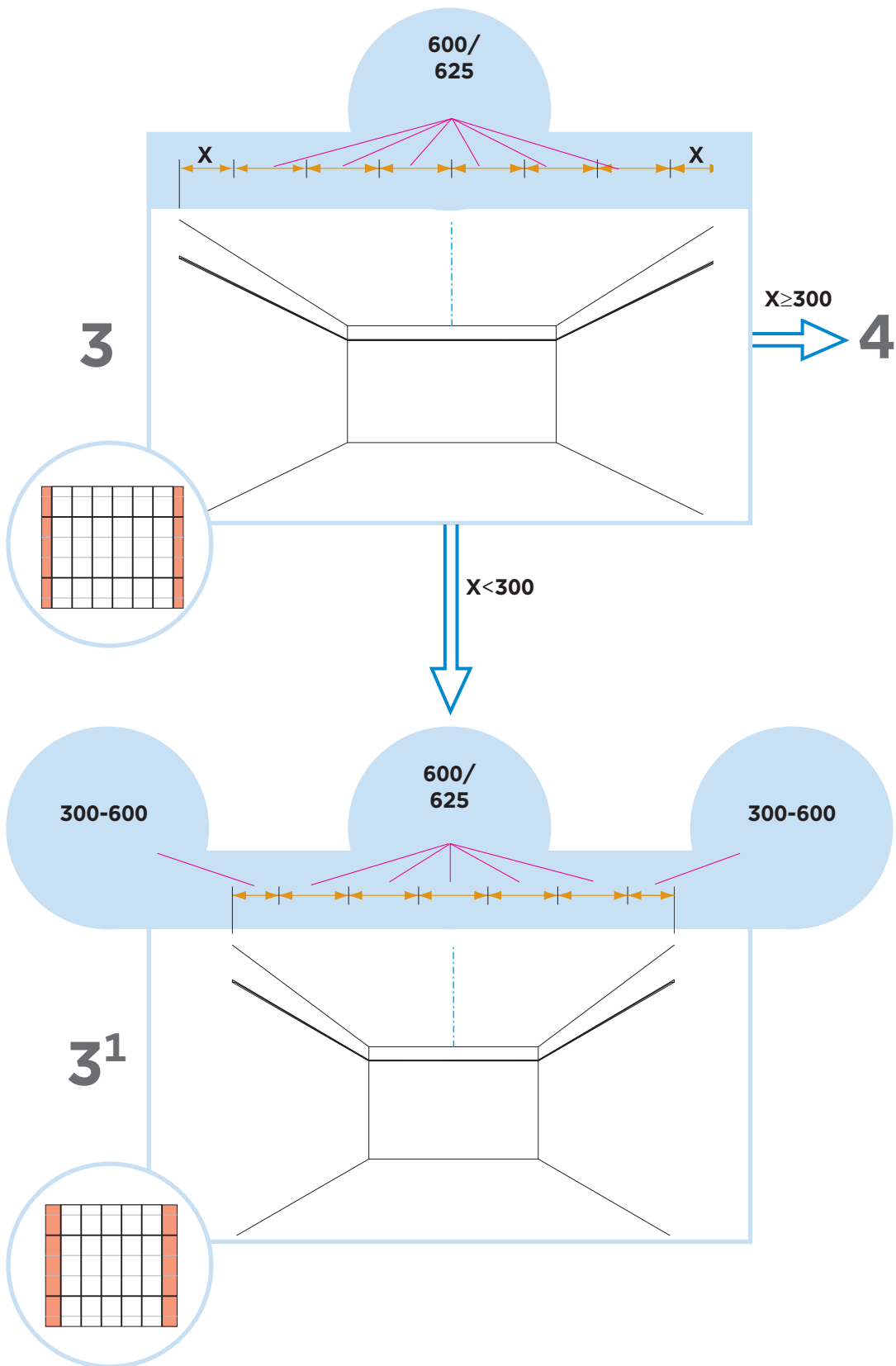

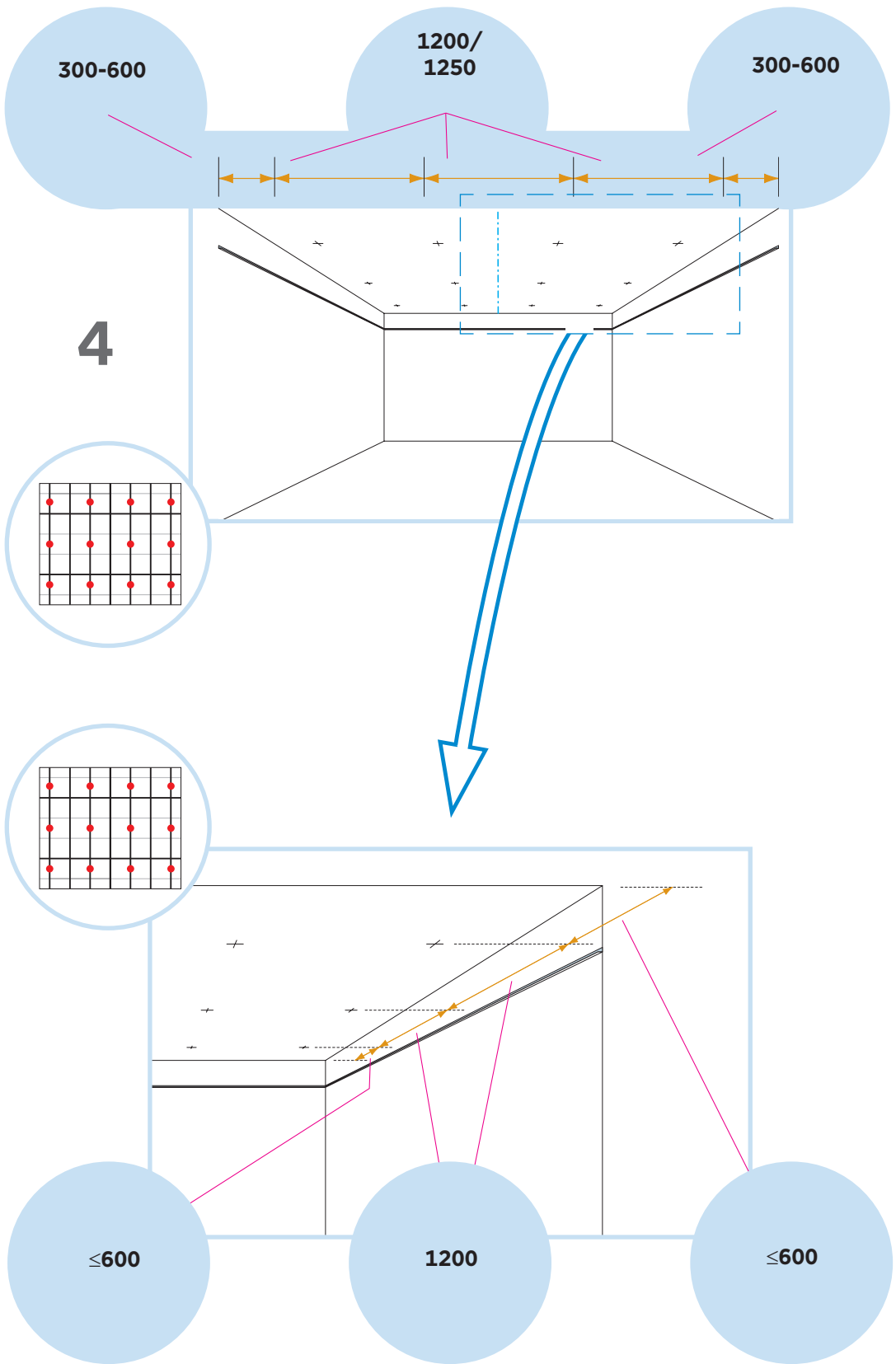

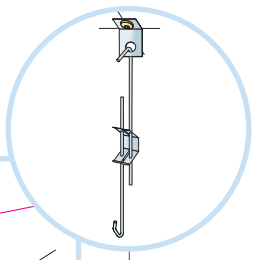
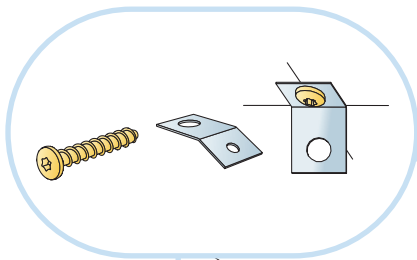

5

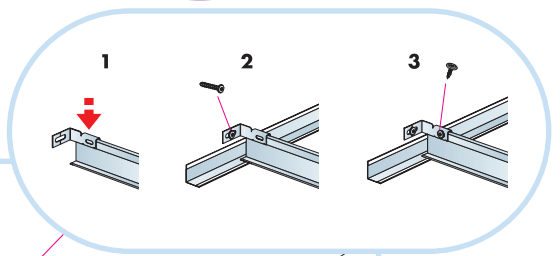
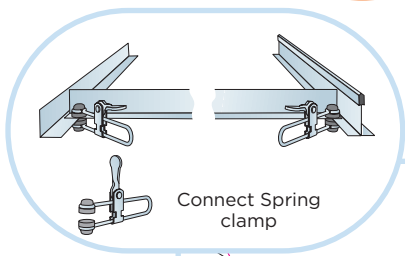
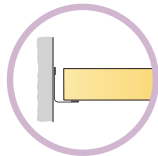
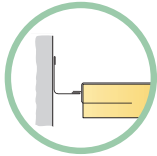
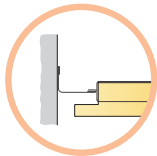
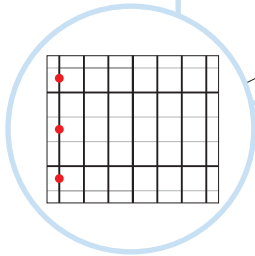
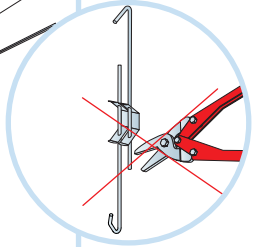
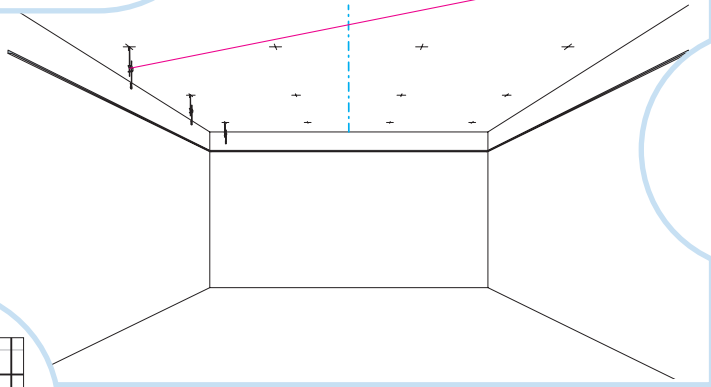

6

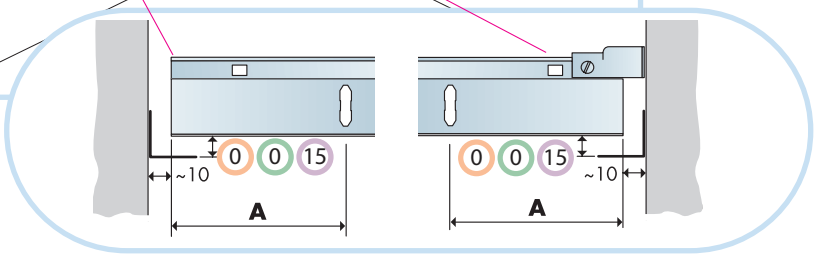
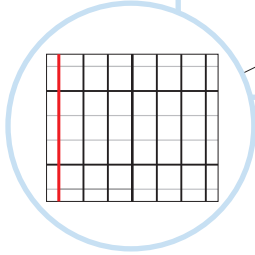
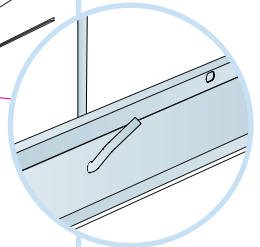
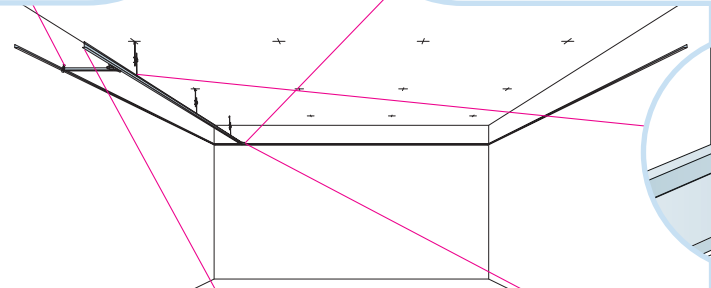

Connect Laser angle

7

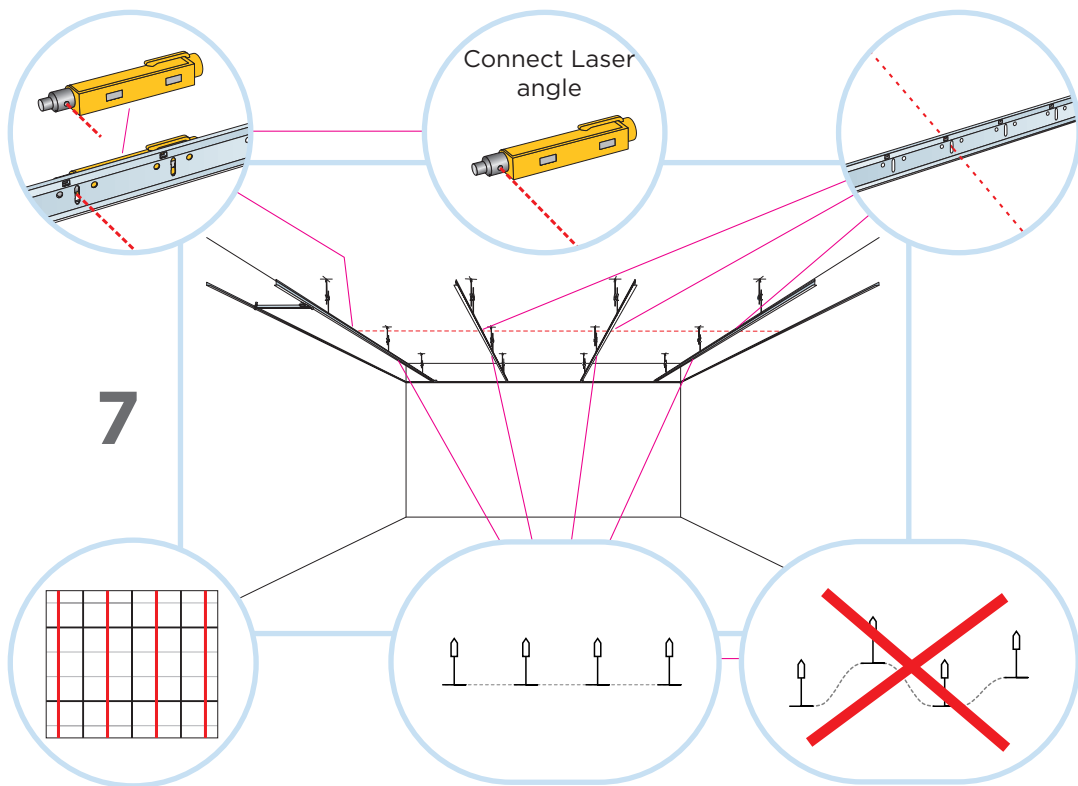

8

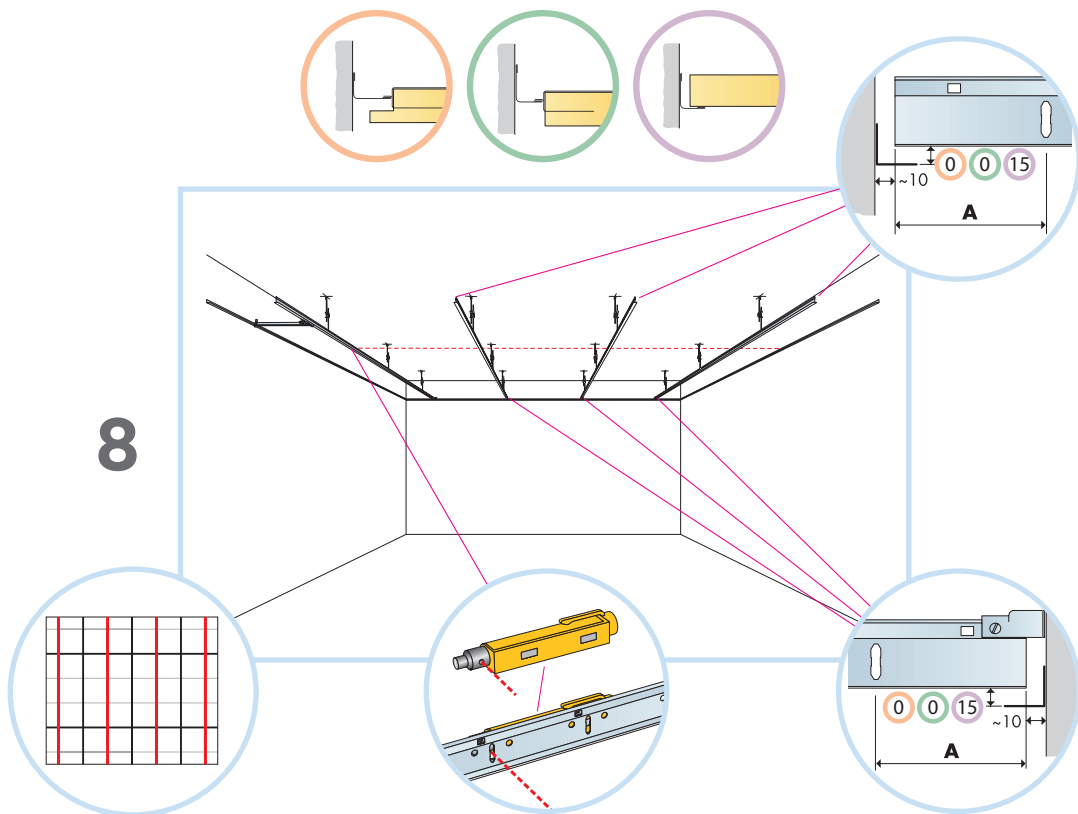

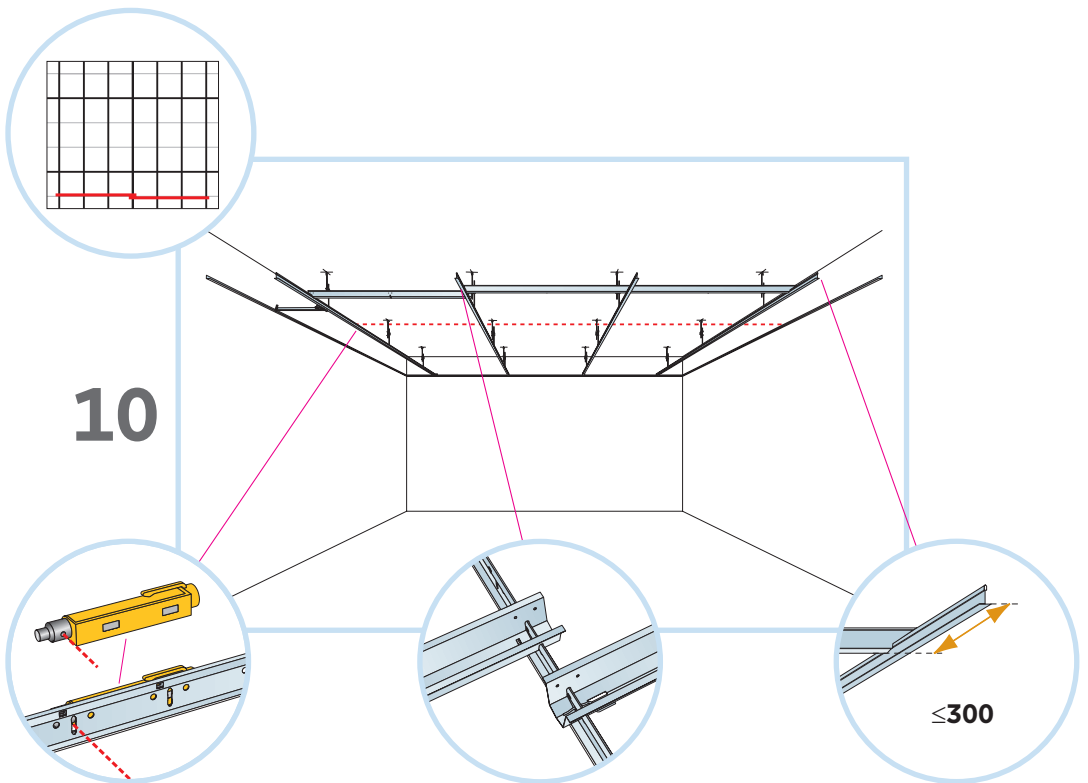
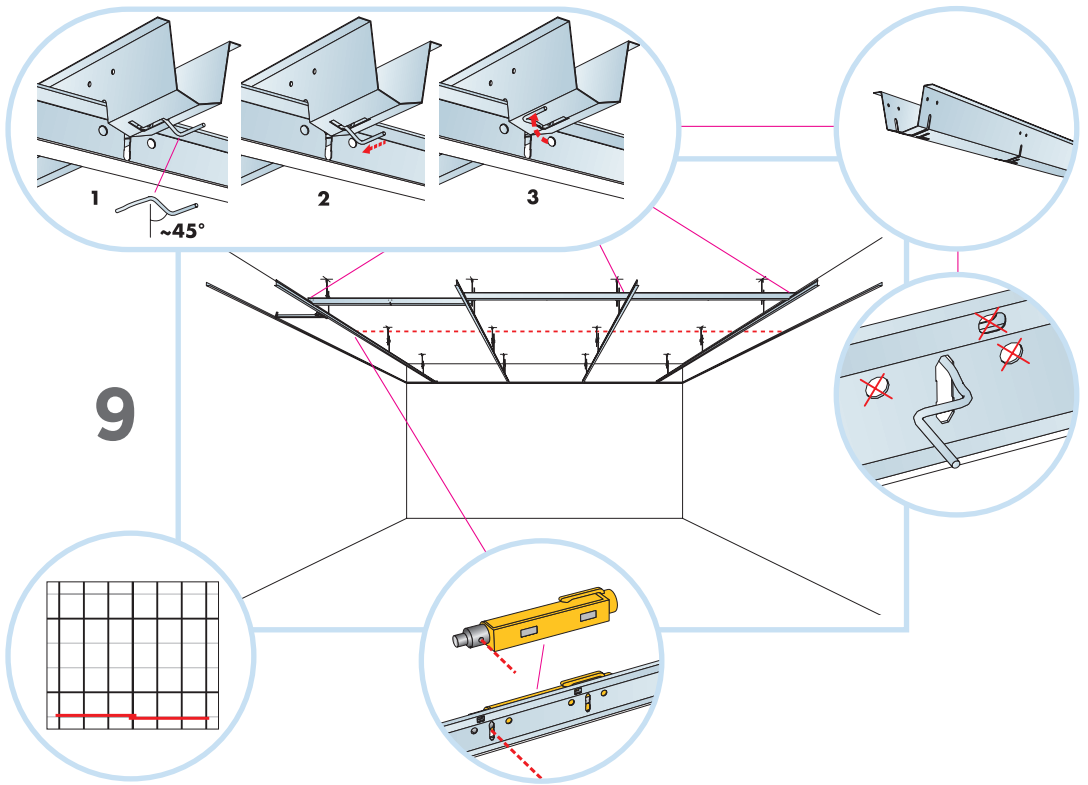

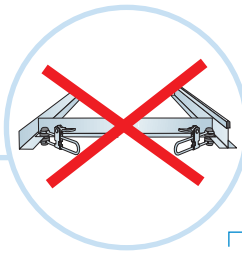
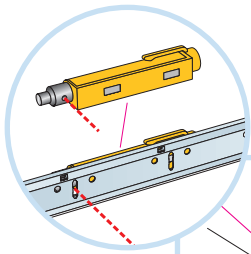

11

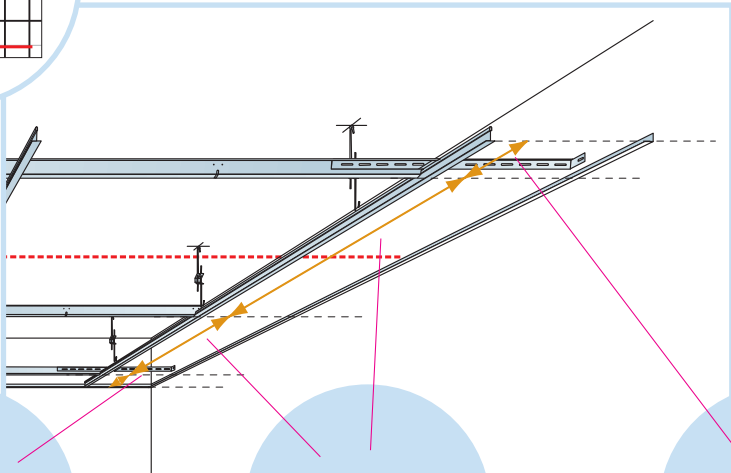
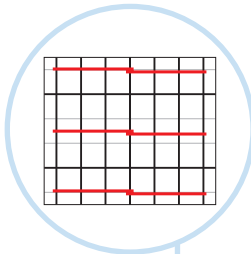
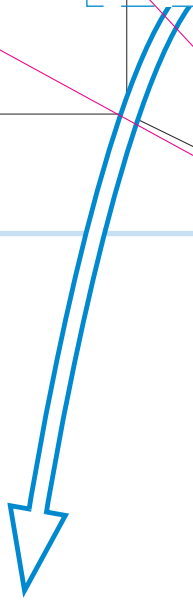
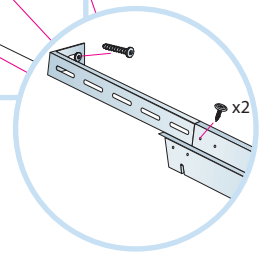
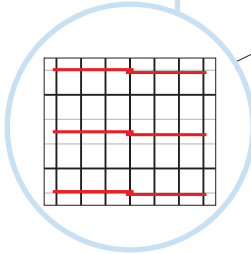

≤300

1500

≤300

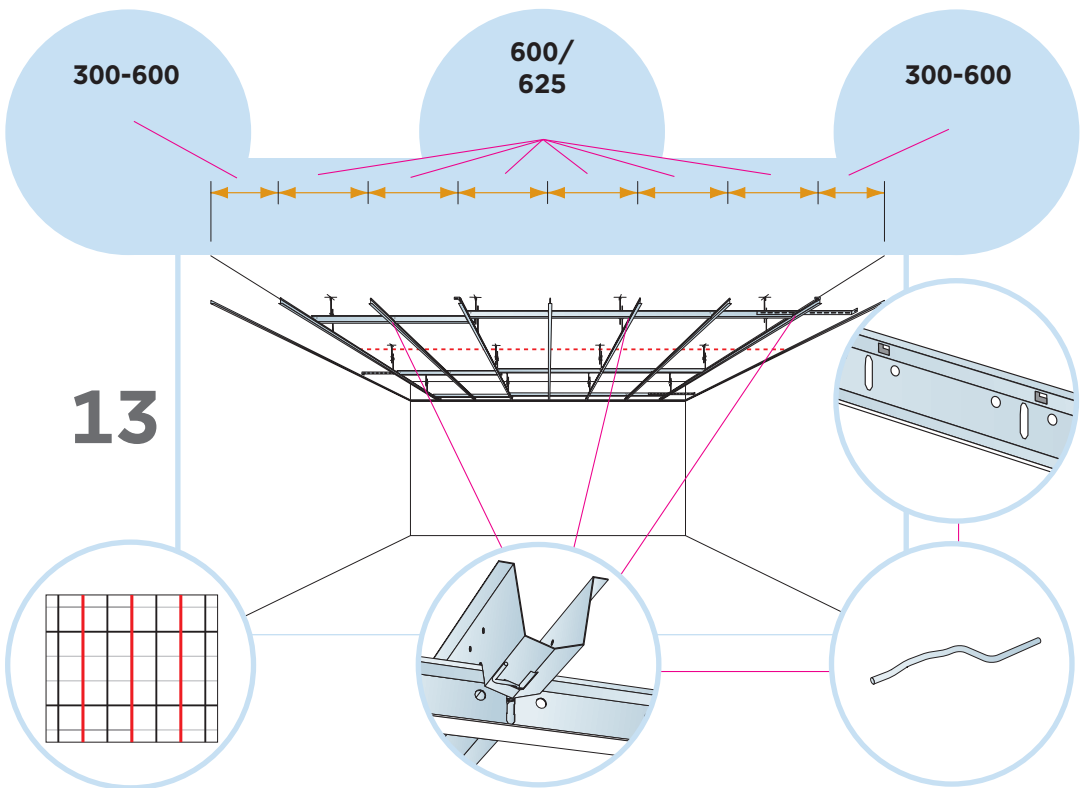
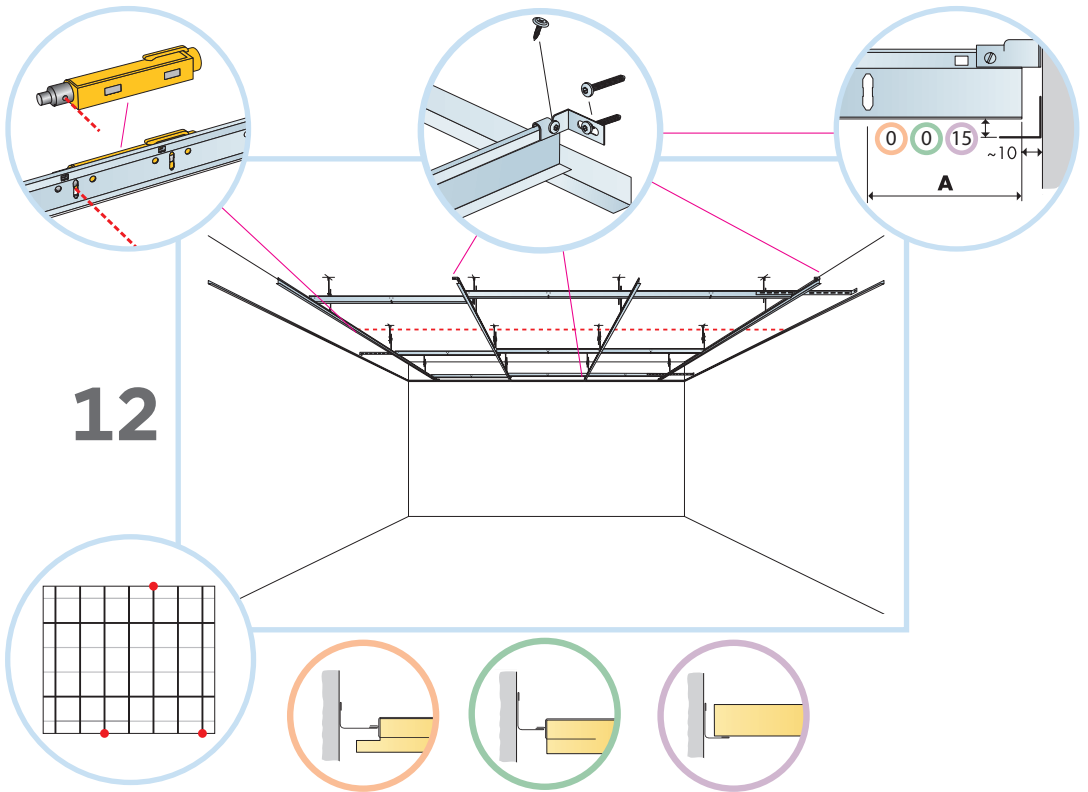

□ 600x600/625x625 → 14

□ 1200x600 → 19

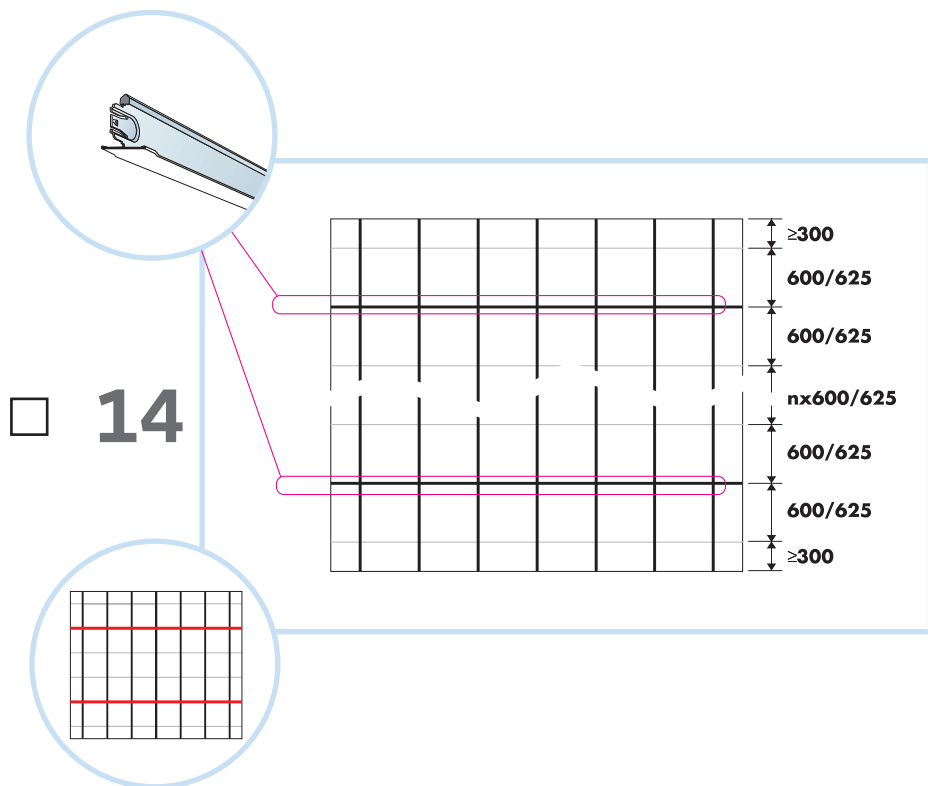

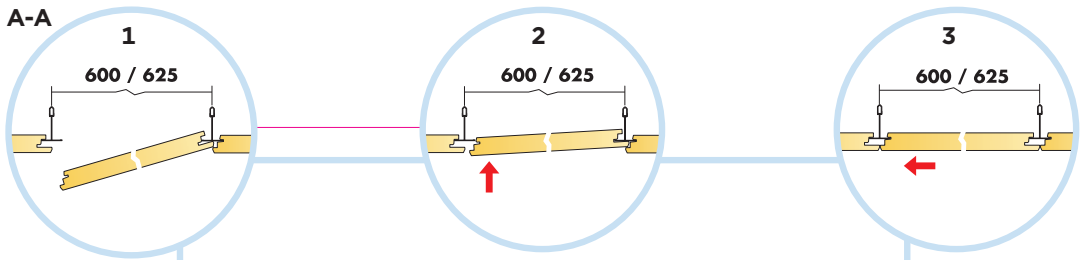

□ 15

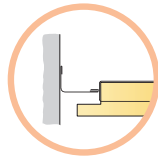
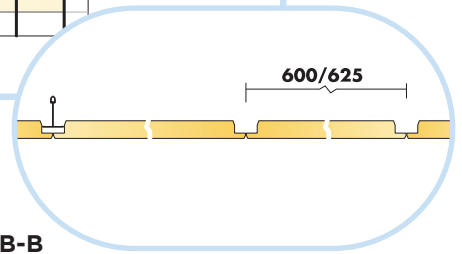
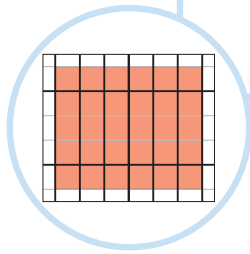
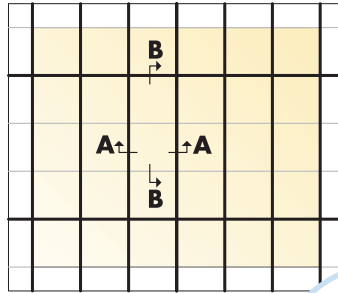

→ 16

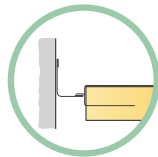

→ 17

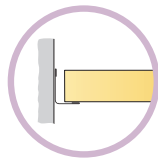

→ 18

Cutting tool 0991

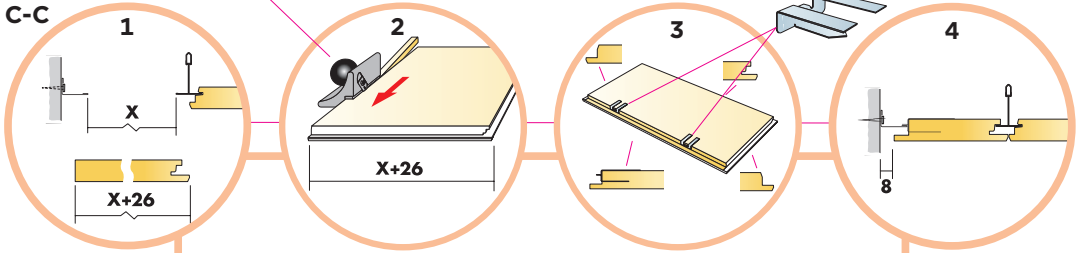

□ **16**

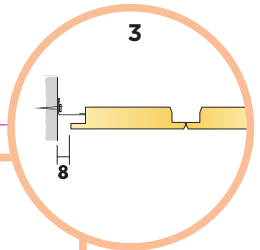
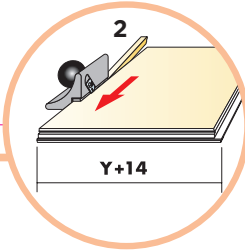
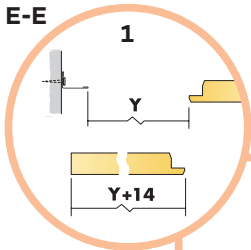
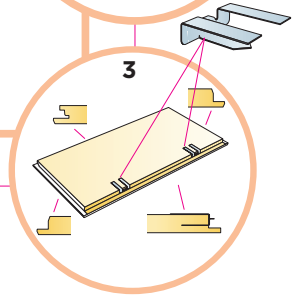
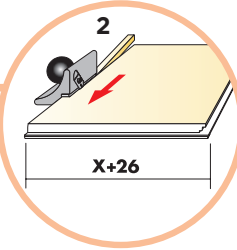
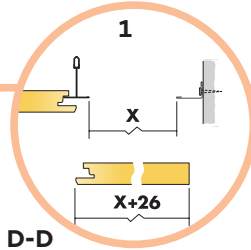
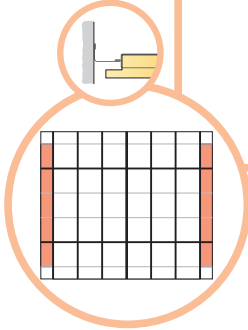
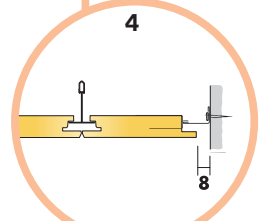
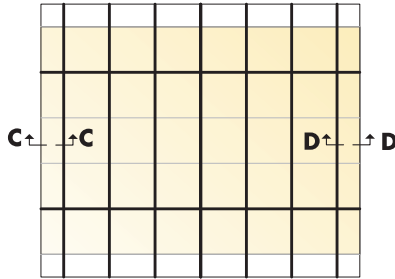

□ **16<sup>1</sup>**

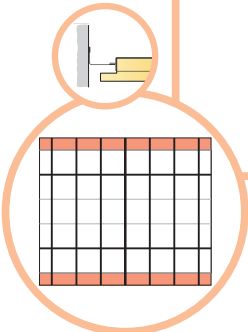
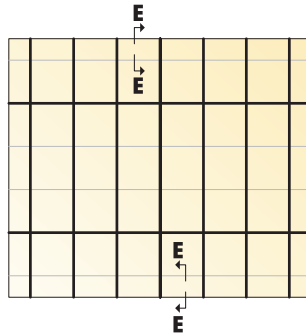

C-C

1

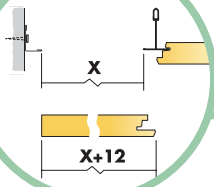

2

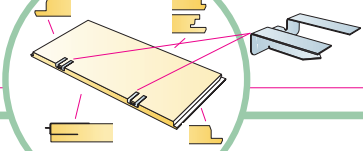

3

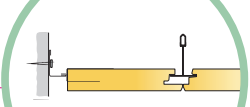

□ 17

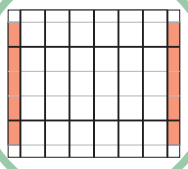

C-C

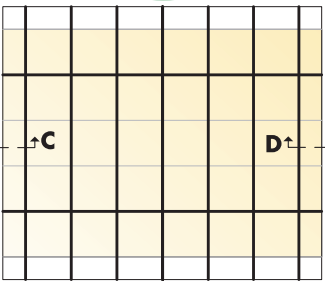

D-D

1

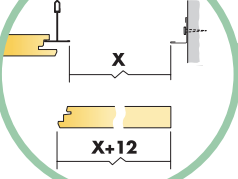

D-D

2

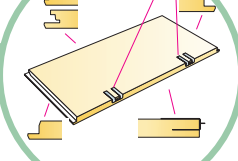

3

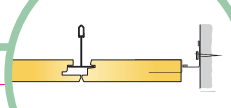

E-E

1

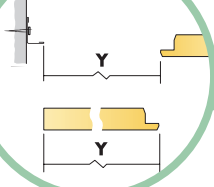

2

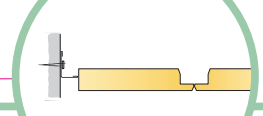

□ 17<sup>1</sup>

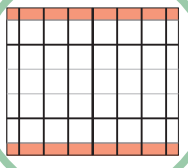

E

E

E

E

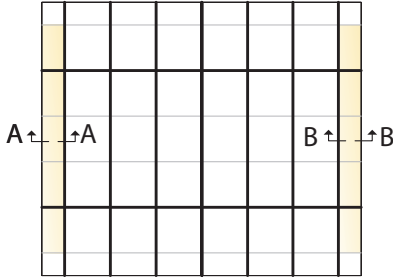
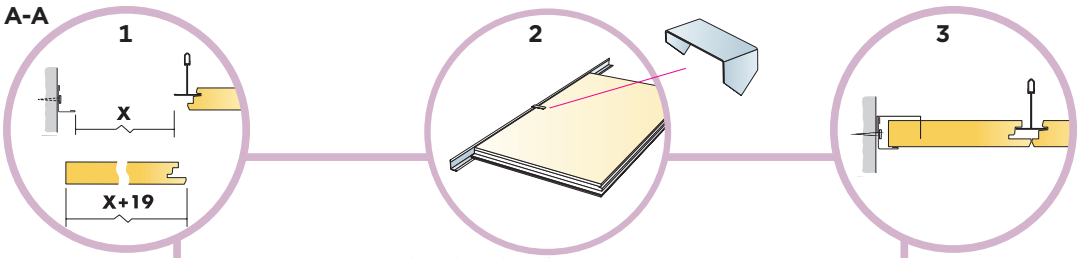

□ **18**

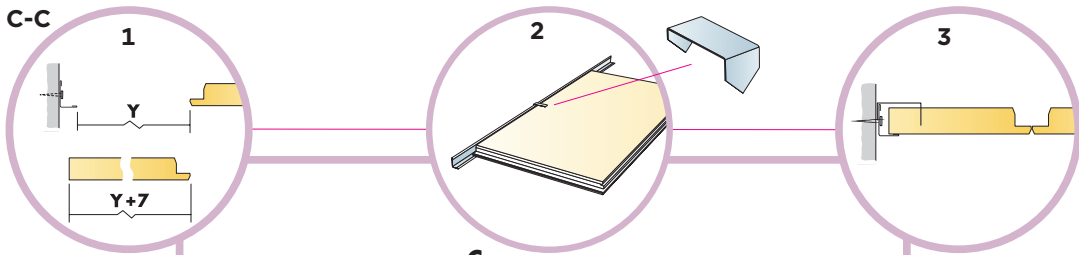
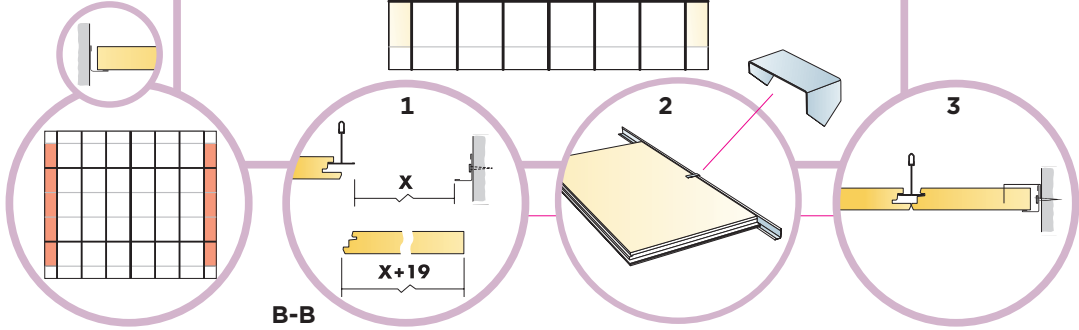

□ **18<sup>1</sup>**

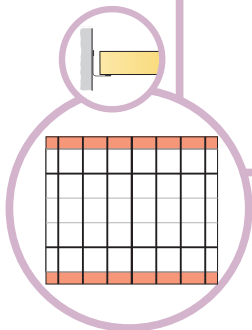
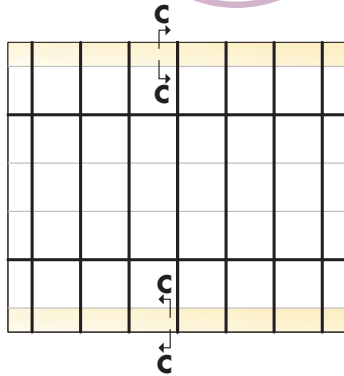

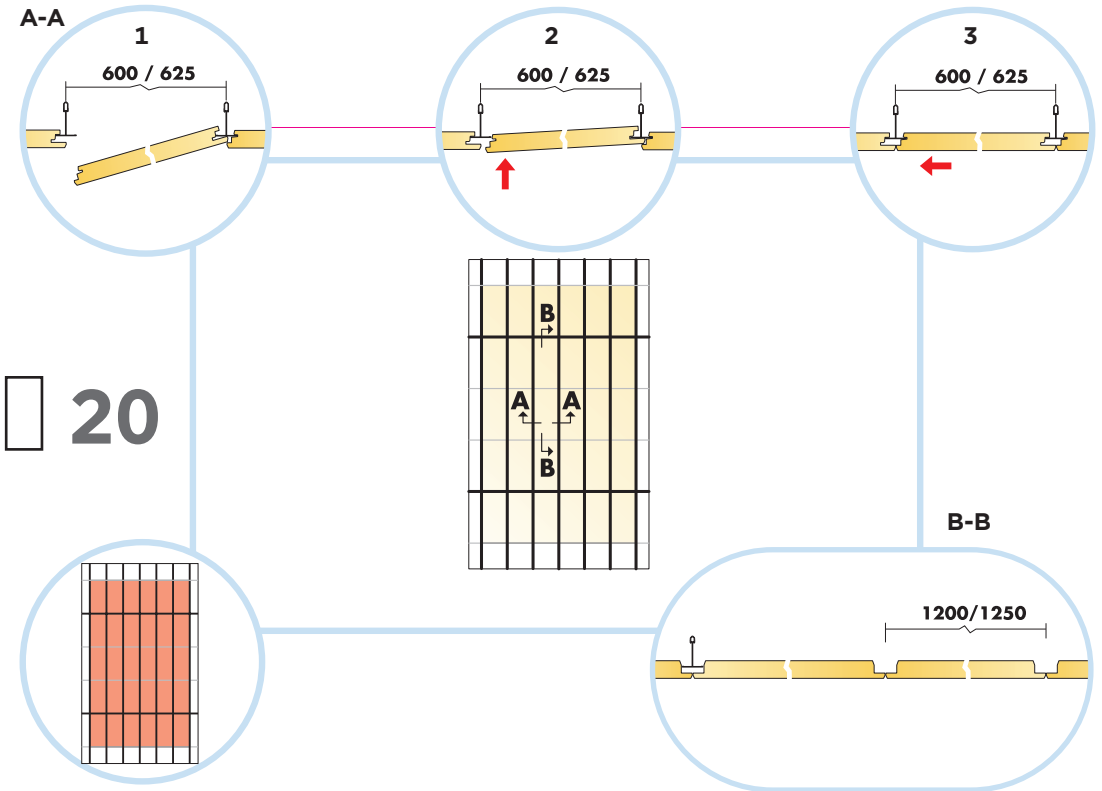
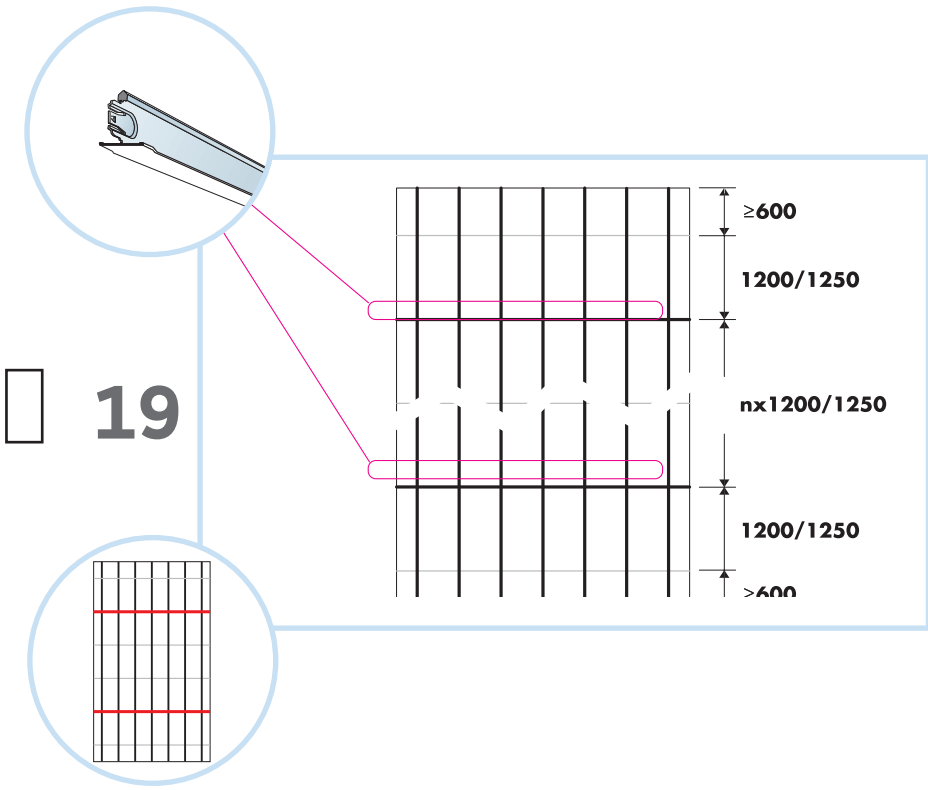

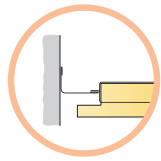

**21**

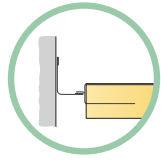

**22**

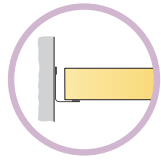

**23**

Cutting tool 0991

C-C

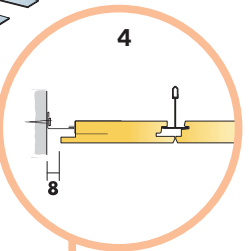
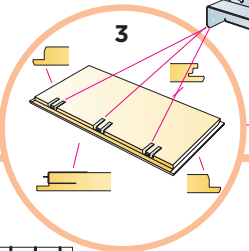
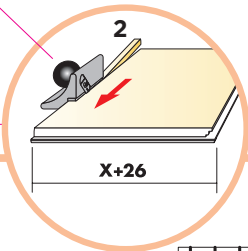
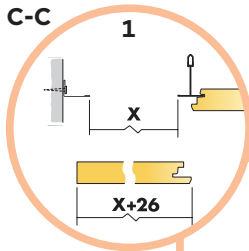

21

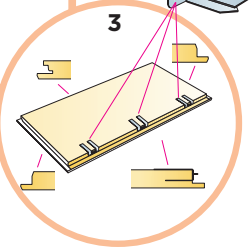
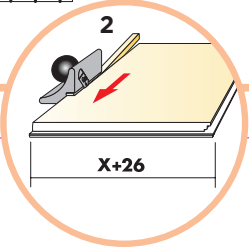
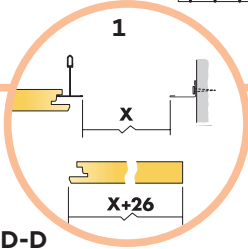
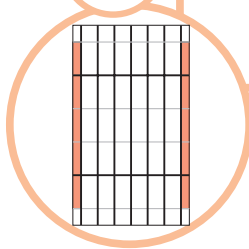
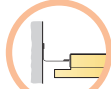
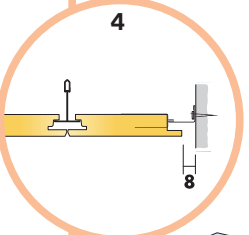
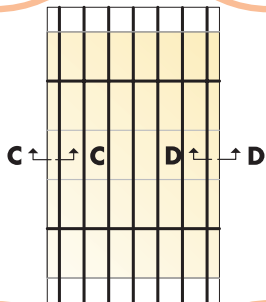

D-D

E-E

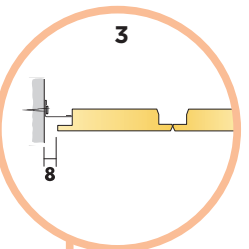
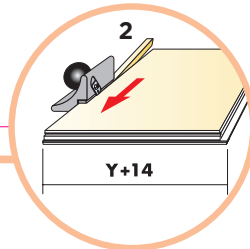
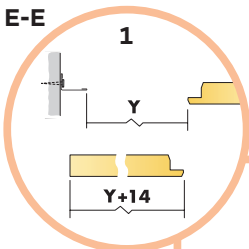

21<sup>1</sup>

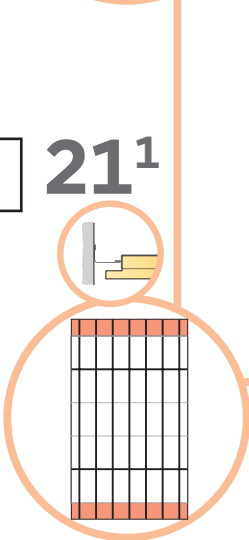
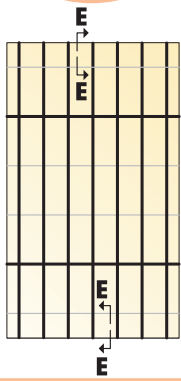

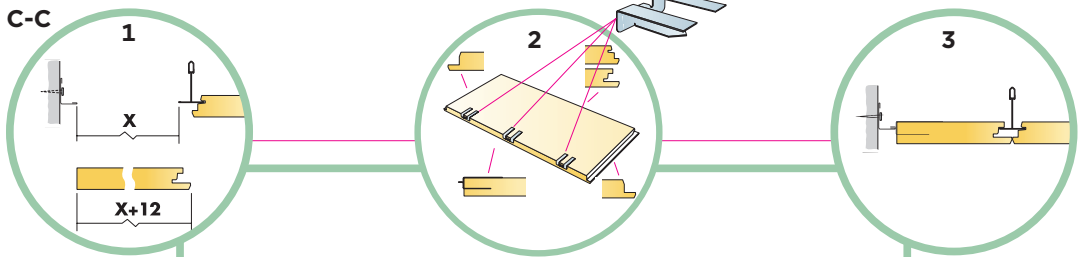

**22**

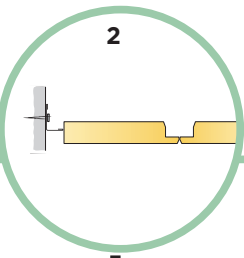
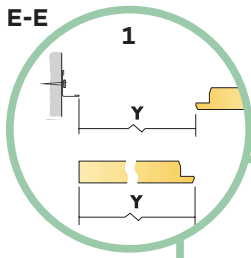
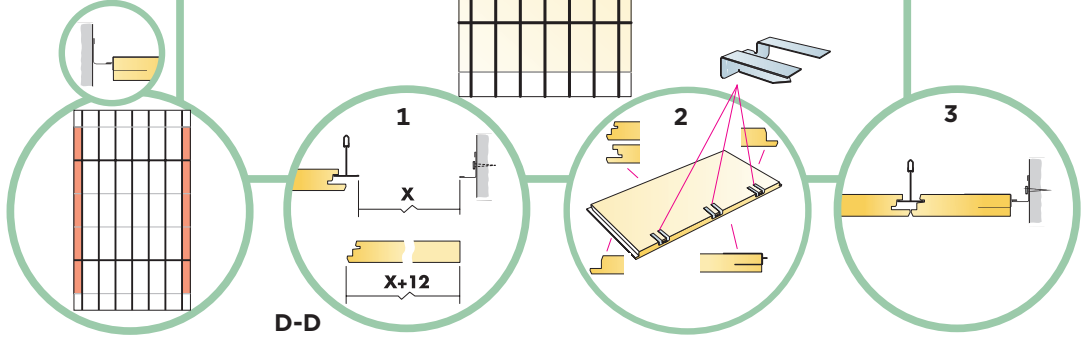
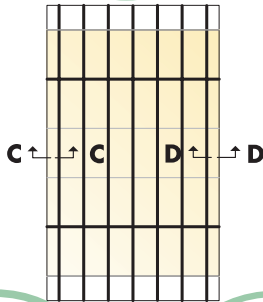

**22<sup>1</sup>**

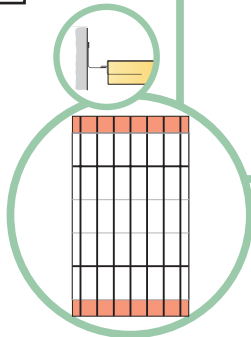
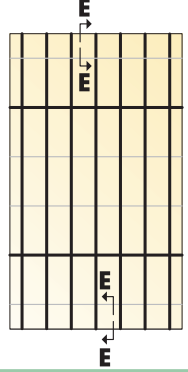

A-A

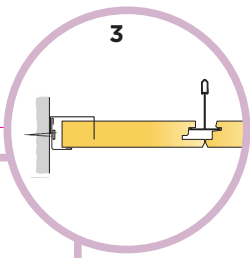
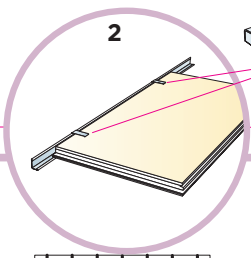
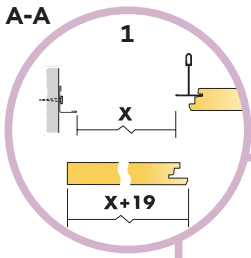

23

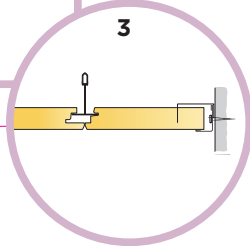
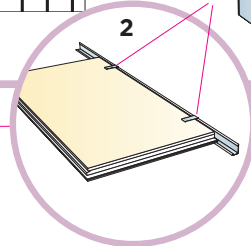
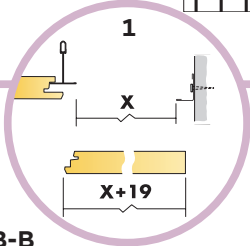
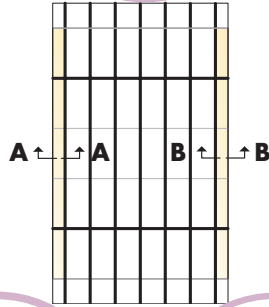
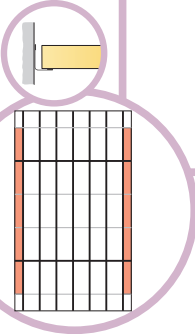

B-B

C-C

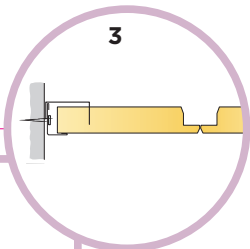
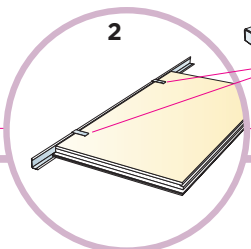
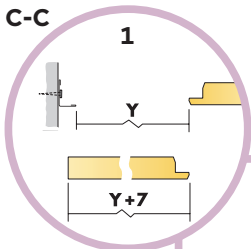

23<sup>1</sup>

