

# ECOPHON HYGIENE PERFORMANCE™ WALL

Ecophon Hygiene Performance™ Wall is an easy to clean, sound absorbing wall panel system suitable for humid areas. The panels withstand advanced cleaning, such as steam and high/low pressure washing on a regular basis.



# Ecophon Hygiene Performance™ Wall

## SYSTEM RANGE

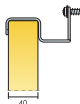

Size, mm	1200x600
Special Fixing	•
Thickness (THK)	40
Inst. Diagr.	M467

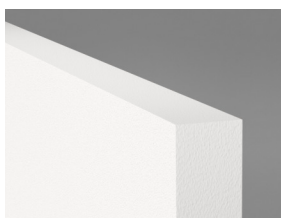

Hygiene Performance Wall



Connect Wall fixing C3



Hygiene Performance Wall C3 system

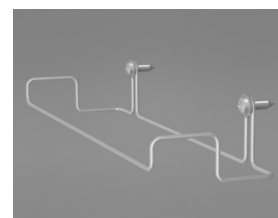

Connect Wall Fixing C3

## TYPE OF APPLICATION

- Additional areas
- Healthcare



## ACOUSTIC

### Sound Absorption

Test results according to EN ISO 354. Classification according to EN ISO 11654.

$\alpha_p$ , Practical sound absorption coefficient

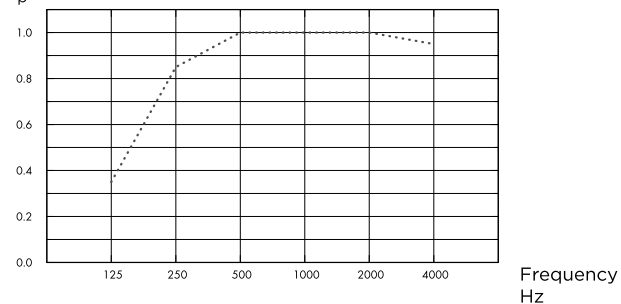

···· Hygiene Performance Wall, 80 mm o.d.s.  
o.d.s = overall depth of system

THK mm	o.d.s. mm	$\alpha_p$ , Practical sound absorption coefficient						$\alpha_w$	Sound absorption class
		125 Hz	250 Hz	500 Hz	1000 Hz	2000 Hz	4000 Hz		
40	80	0.35	0.85	1.00	1.00	1.00	0.95	1.00	A

THK mm	o.d.s. mm	NRC	SAA
40	80	0.95	0.95

## INDOOR AIR QUALITY



Certificate / Label	
Eurofins Indoor Air Comfort®	IAC Gold
French VOC	A+



## CRADLE TO CRADLE CERTIFIED®

This product is Cradle to Cradle Certified® at Bronze level (version 4.0).



## MATERIAL HEALTH

This product has received a C2C Certified Material Health Certificate™ at the Silver level (standard version 4.0). The C2C Certified Material Health Certificate™ is a verification of the health and safety of a product's composition using the Material Health requirements of the Cradle-to-Cradle Certified Product Standard.



## CARBON FOOTPRINT

Life-cycle stages A1 to C4 from EPD, in conformity with ISO 14025 / EN 15804

	kg CO <sub>2</sub> equiv/m <sup>2</sup>
Hygiene Performance Wall	7,13



## CIRCULARITY

Minimum post-consumer recycled content	54%
Recyclability	Fully recyclable



## FIRE SAFETY

The glass wool core of the tiles is tested and classified as non-combustible according to EN ISO 1182.

Country	Fire standard	Class
Europe	EN 13501-1	A2-s1,d0



## HUMIDITY RESISTANCE

Class C, relative humidity 95% and 30°C, according to EN 13964:2014



## VISUAL APPEARANCE

White 500, nearest NCS colour sample S 0500-N, 84% light reflectance.



## CLEANABILITY

Standard/Method	Frequency
Dusting	Daily
Wet wiping	Weekly
Steam cleaning	4/year
Low pressure cleaning	2/year
High pressure cleaning	2/year
Hydrogen peroxide vapor	•
UV-C, BIFMA HCF 8.1-2019	•



## SURFACE ENDURANCE

Product tested according to ISO 11998, and withstand 200 cycles.



## CHEMICAL RESISTANCE/DISINFECTION

Tested according to ISO 11998 and withstands the following chemicals or disinfectants.

Chemical	Active Substance	Concentration
Actichlor plus	NaDCC (Sodium Dichloroisocyanurate)	1%
LifeClean	Chlorine dioxide	Undiluted
Etanol	Etanol	70%
Chlorine	Sodium Hypochlorite solution	2,5%
Virkon S	Dipotassium peroxodisulphate; Sulphamic acid	1%
Isopropanol	Isopropyl Alcohol	70%
Oxivir Excel	Hydrogen peroxide	0,5%
Sumabac D10	Quaternary ammonium compound, Sodium carbonate	1%
Suredis VT1	n-(3-aminopropyl)-n-dodecylpropan-1,3-diamin	1%
Enduro Chlor VE5	Potassium hydroxide	1,5%
Acplusfoam VF59	Nitric Acid	5%



## MOULD AND BACTERIAL RESISTANCE

Standard/Method	Class
ISO 846 :2019 method C (for bacterium)	0 (No growth under the microscope)
ASTM D3273-16 (for fungi)	10 (0% growth on the surface)



## CLEAN ROOM

	Standard/Method	Class
ISO 14644	Particle cleanliness class	ISO 4
NF S 90-351	Microbiological class	M1/area 4
NF S 90-351	Particle elimination kinetics	CP(0,5) 5



## ACCESSIBILITY

The tiles are demountable.



## INSTALLATION

Installed according to installation diagrams, installation guides and drawing aid. For information regarding minimum overall depth of system see quantity specification.



## PACKAGING INFORMATION

Information is indicative and subject to change.

	Panels / crt
1200x600x40	6



## SYSTEM WEIGHT

Weight information is indicative and subject to variation.

	kg/m <sup>2</sup>
Hygiene Performance Wall	4,0



## MECHANICAL PROPERTIES

See table about Max live load and Min load bearing capacity and Functional demands, Mechanical properties at [www.ecophon.com](http://www.ecophon.com).



## CE

Ecophon ceiling systems are CE marked according to the European harmonized standard EN13964:2014. CE marked construction products are covered by a Declaration of Performance (DOP) which enables customers and users to easily compare performance of products available on the European market.

## COLOURS AND DESIGN

Akutex™ HS

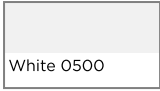

White 0500

Wall installation

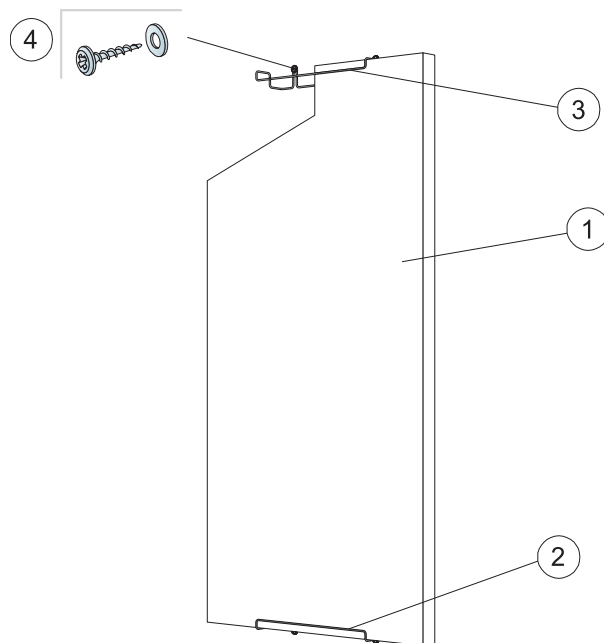

© Saint-Gobain Ecophon AB

Installation diagram (M467) for Ecophon Hygiene Performance™ Wall C3

Quantity specification (excl. wastage)

		Size, mm
		<b>1200x600</b>
1	Hygiene Performance Wall	1,4/m <sup>2</sup>
2	Connect Wall Fixing C3, vertical installation	2/panel
3	Connect Wall Fixing C3, horizontal installation	4/panel
4	Wall screw, A2 material (not supplied by Ecophon)	2/wall fixing
Δ Min. overall depth of system: 90 mm		

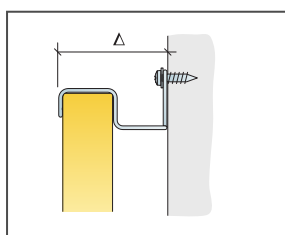

See Quantity Specification

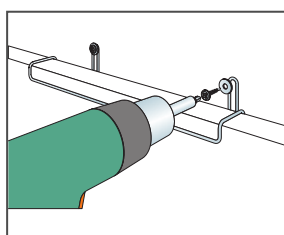

Installation with wall screw in stainless steel (A2) material

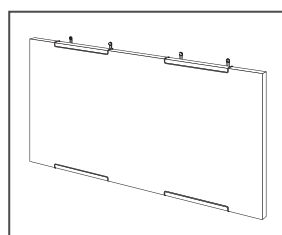

Horizontal installation of Performance Wall C3

Size, mm	Max live load (N)	Min load bearing capacity (N)
1200x600x40	0	-

Live load/load bearing capacity